



(19) **United States**

(12) **Patent Application Publication**  
**Galitsky**

(10) **Pub. No.: US 2021/0042473 A1**

(43) **Pub. Date: Feb. 11, 2021**

(54) **ENABLING CHATBOTS BY VALIDATING ARGUMENTATION**

**Publication Classification**

(71) Applicant: **Oracle International Corporation**,  
Redwood Shores, CA (US)

(51) **Int. Cl.**  
**G06F 40/30** (2006.01)  
**G06F 40/205** (2006.01)  
**G06F 40/253** (2006.01)

(72) Inventor: **Boris Galitsky**, San Jose, CA (US)

(52) **U.S. Cl.**  
CPC ..... **G06F 40/30** (2020.01); **G06F 40/253**  
(2020.01); **G06F 40/205** (2020.01)

(73) Assignee: **Oracle International Corporation**,  
Redwood Shores, CA (US)

(57) **ABSTRACT**

(21) Appl. No.: **17/003,593**

Systems, devices, and methods of the present invention validate argumentation in text. In an example, an application forms a communicative discourse tree from a subset of text by matching each fragment of the subset that has a verb to a verb signature. The application identifies that the subset includes an argument by applying a classification model trained to detect argumentation to the communicative discourse tree. The application further creates a logic system based on a claim of the argument, a domain definition clause associated with a domain of the text, a set of defeasible rules based on the communicative discourse tree, and a set of facts from one or more of the communicative actions of the communicative discourse tree. The application evaluates a consistency of the argument with respect to itself and with respect to the domain definition clauses by solving the logic system, thereby validating a claim associated with the argument.

(22) Filed: **Aug. 26, 2020**

**Related U.S. Application Data**

(63) Continuation of application No. 16/260,939, filed on Jan. 29, 2019, now Pat. No. 10,817,670, which is a continuation-in-part of application No. 16/010,091, filed on Jun. 15, 2018, now Pat. No. 10,679,011, which is a continuation-in-part of application No. 15/975,683, filed on May 9, 2018, now Pat. No. 10,796,102.

(60) Provisional application No. 62/623,999, filed on Jan. 30, 2018, provisional application No. 62/646,795, filed on Mar. 22, 2018.

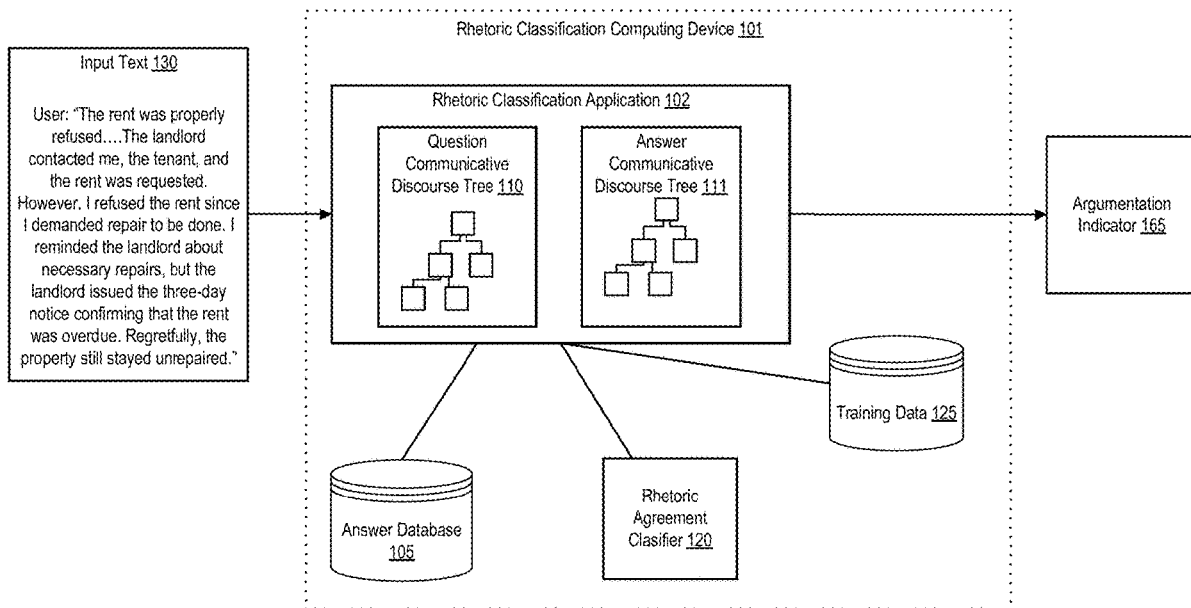

100

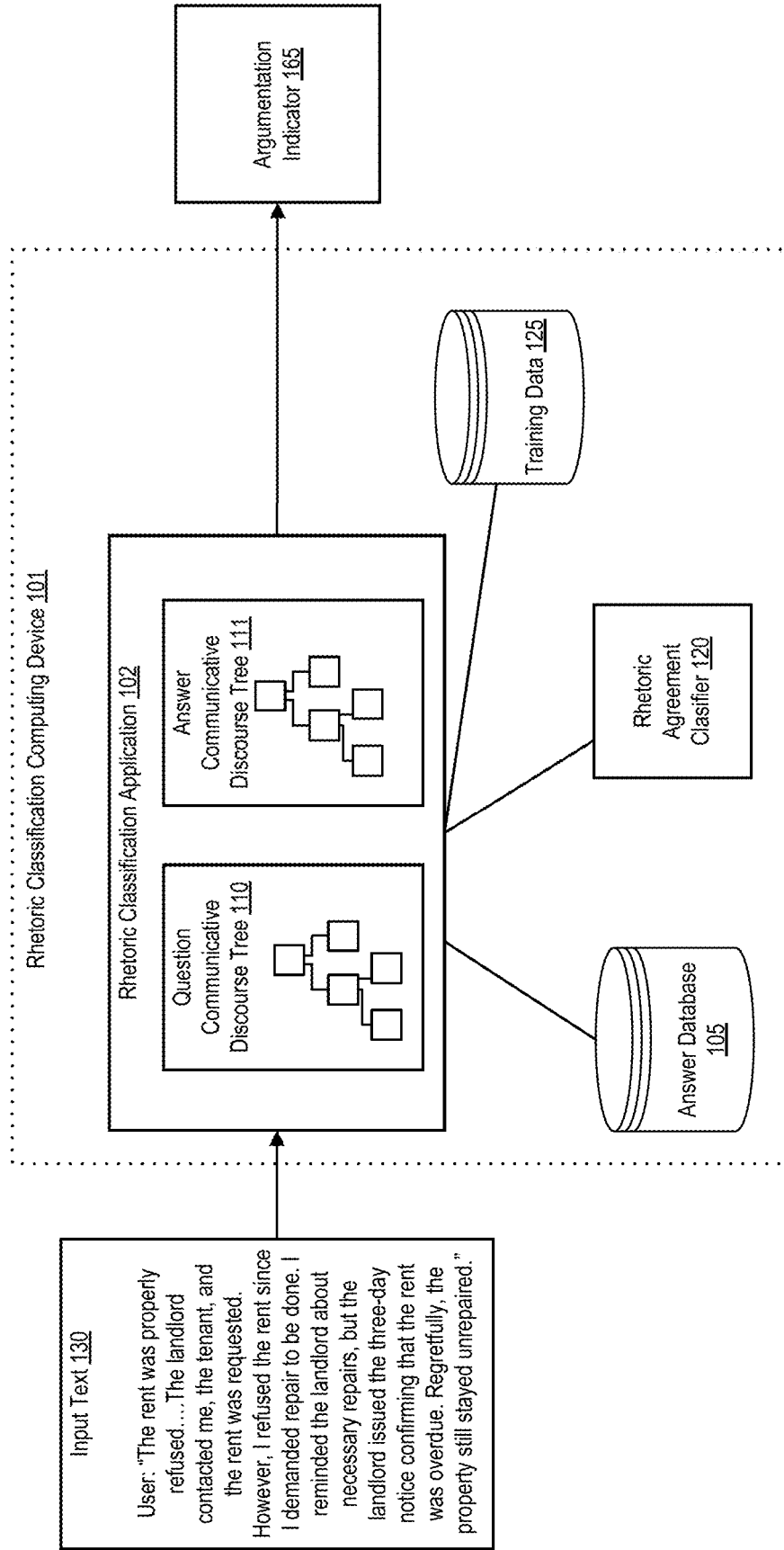

FIG. 1

200

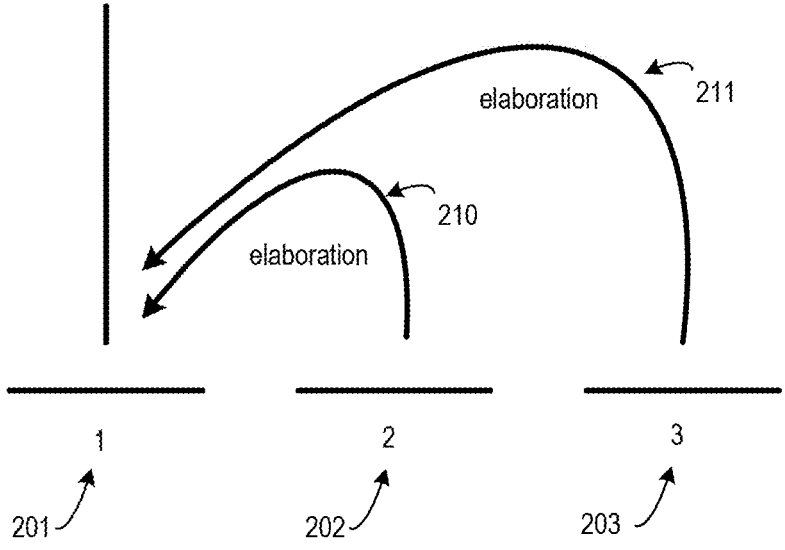

FIG. 2

300

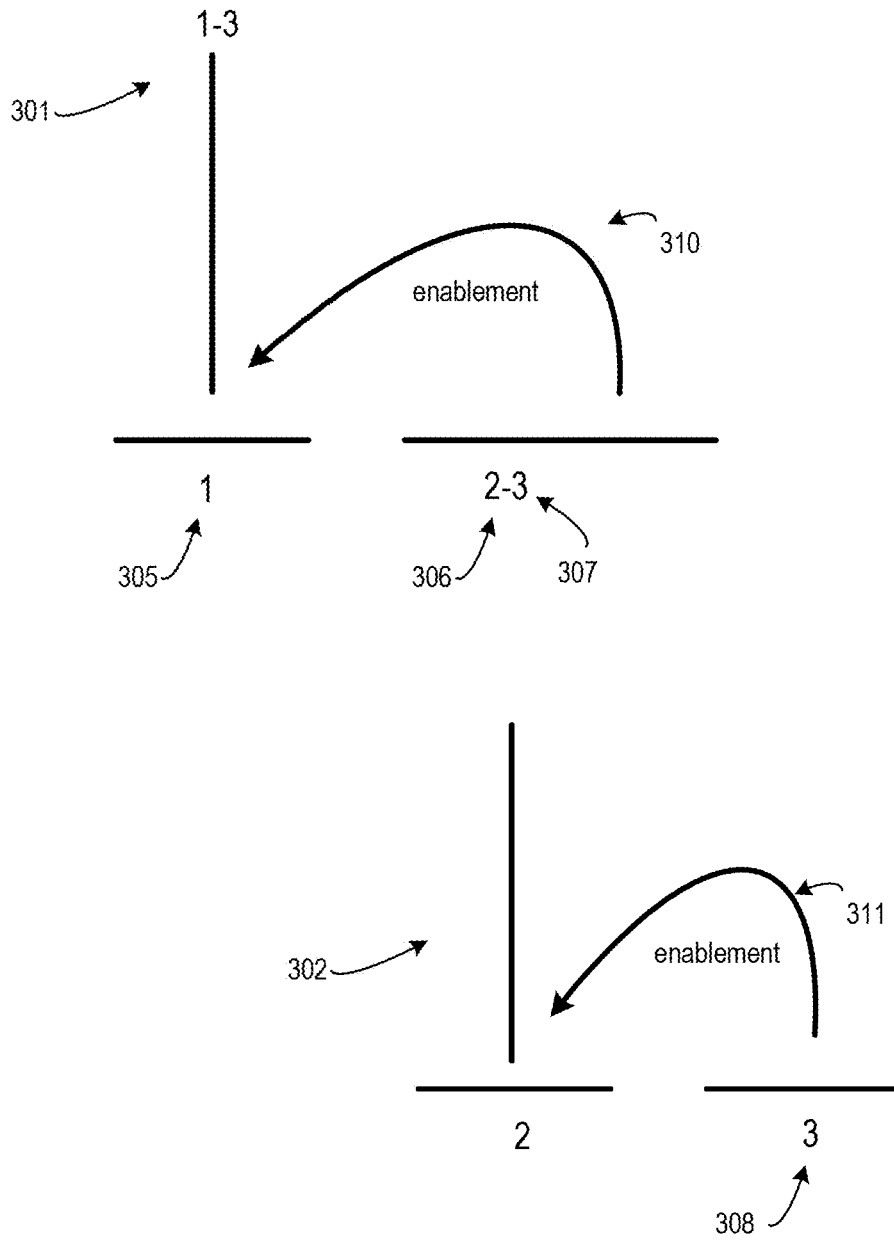

FIG. 3

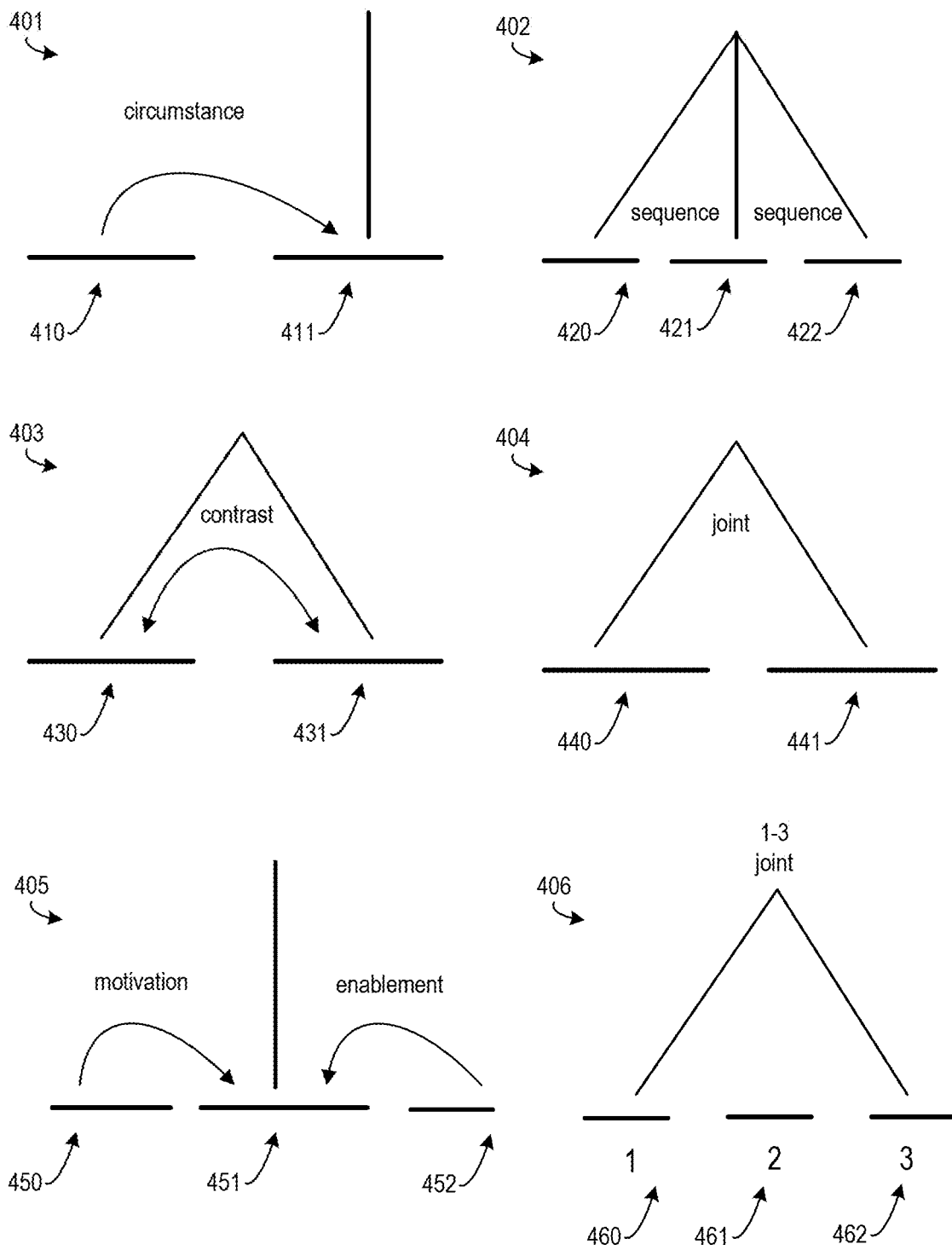

FIG. 4

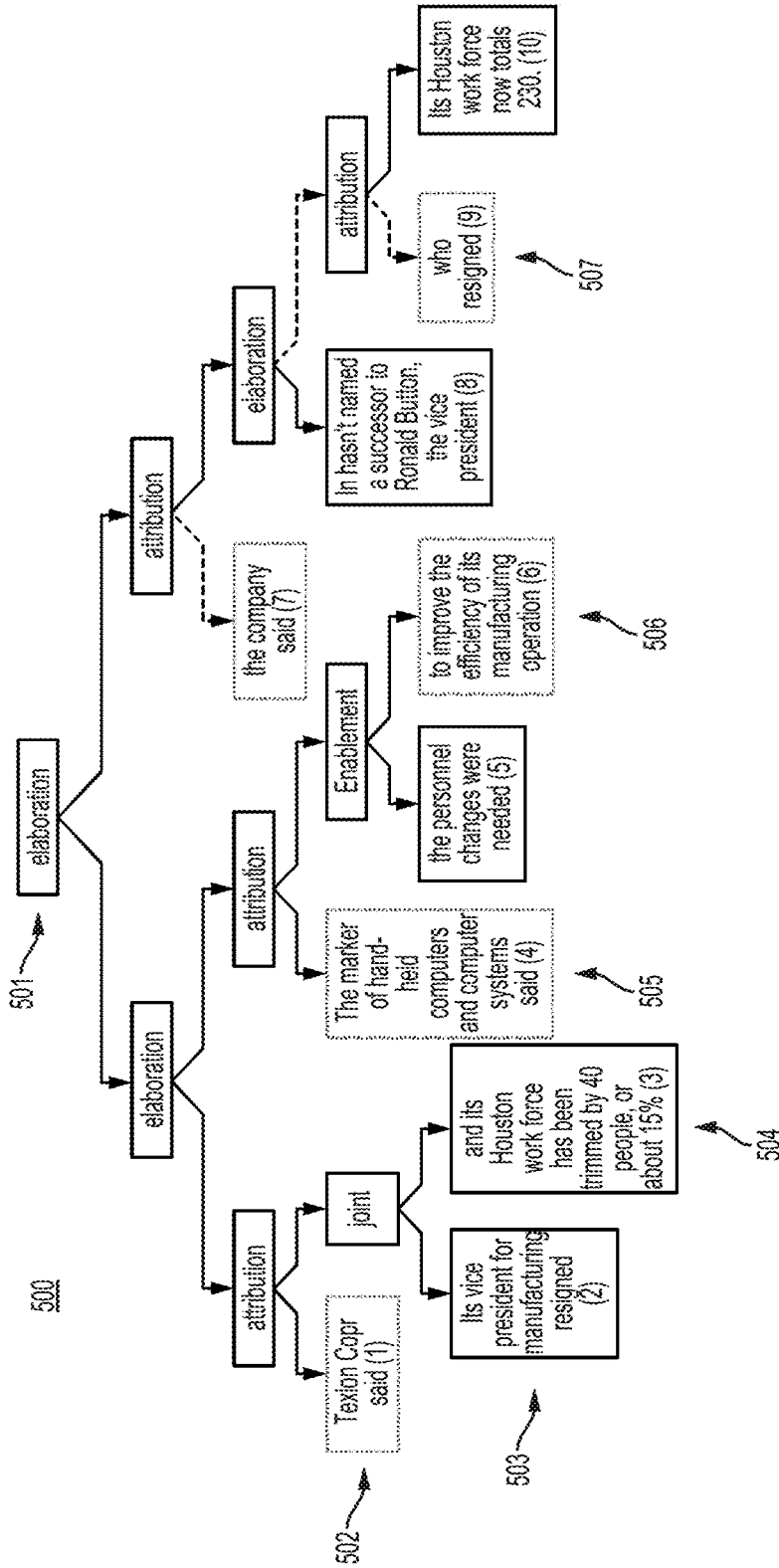

FIG. 5

600

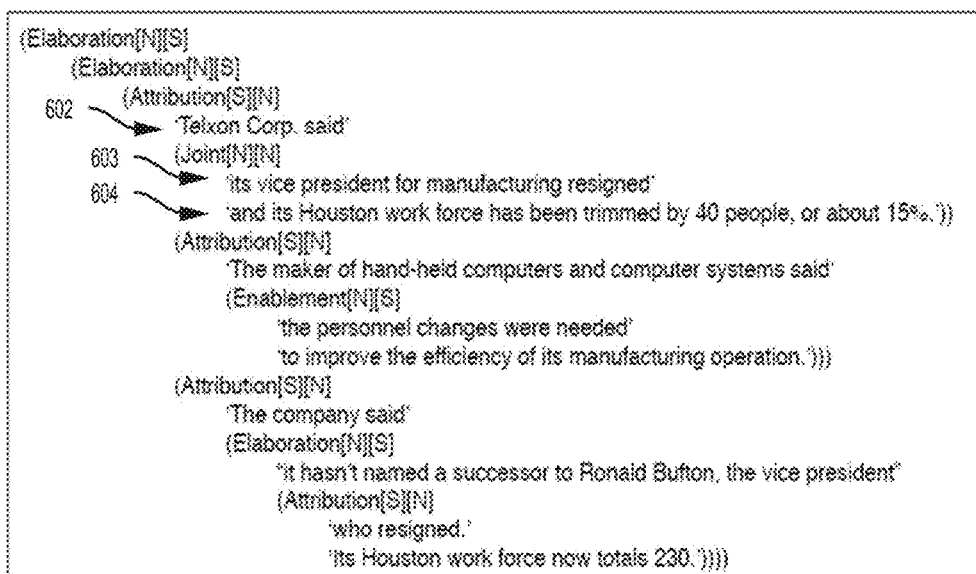

FIG. 6

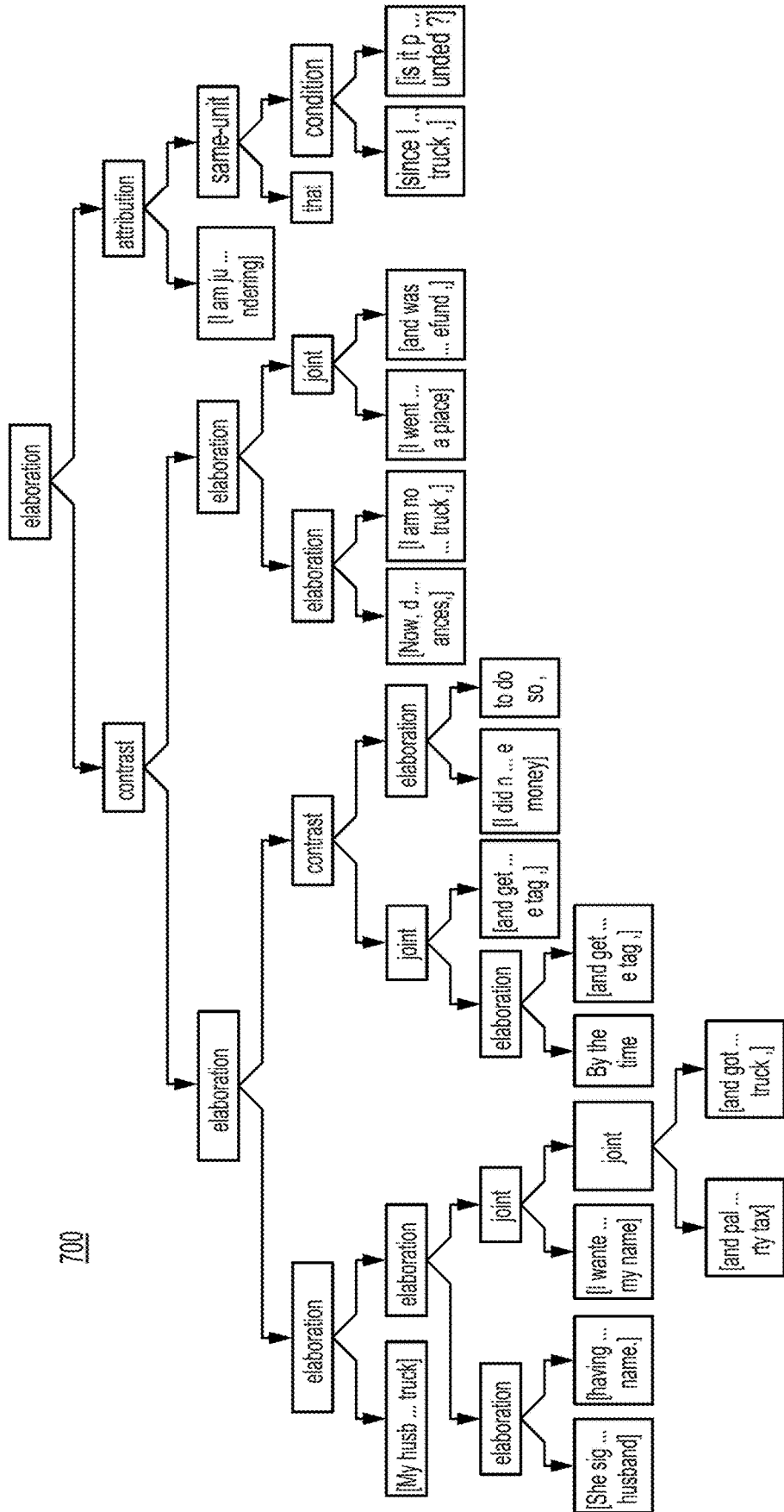

FIG. 7



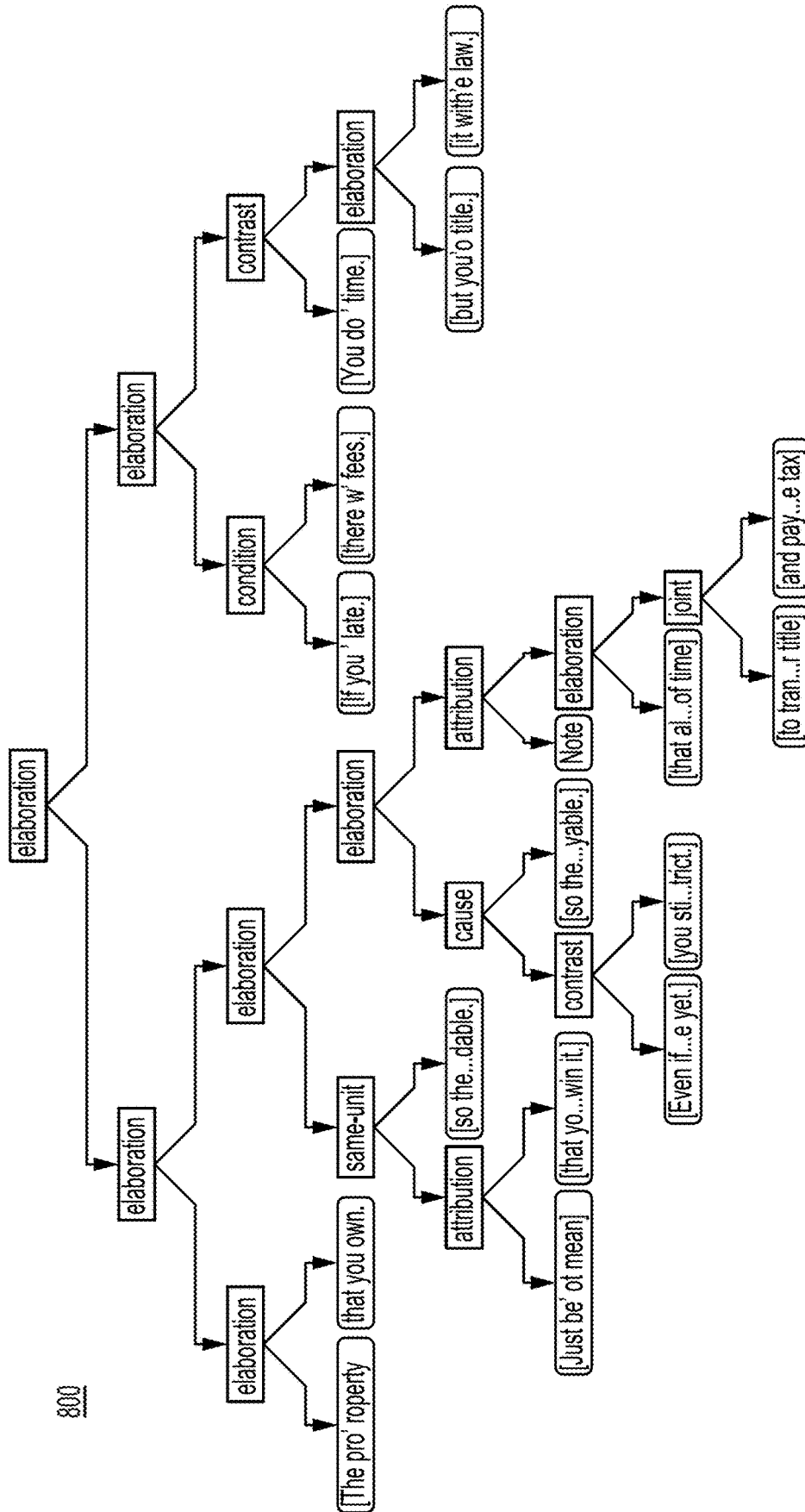

FIG. 8

900

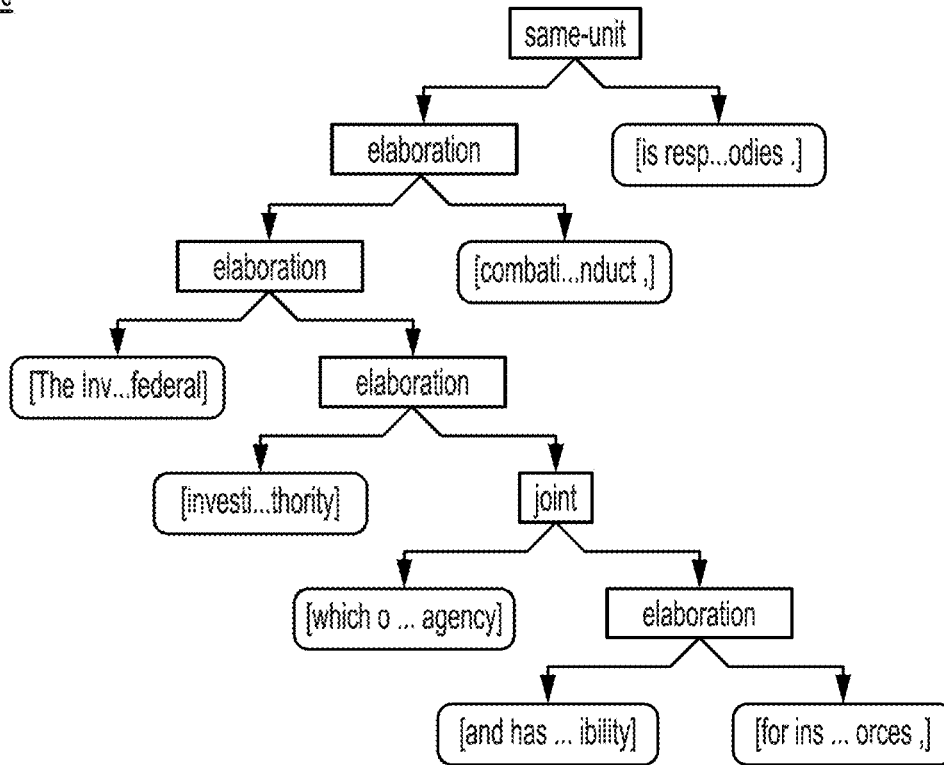

FIG. 9

1000

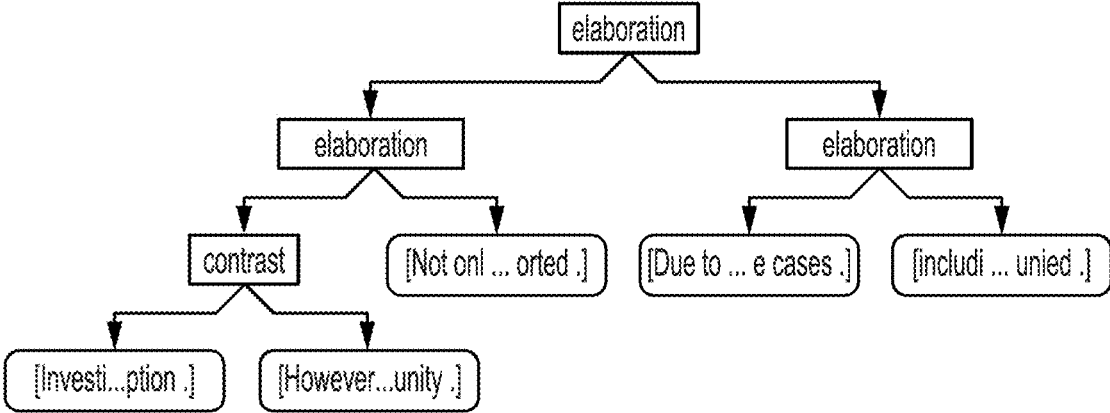

FIG. 10

1100

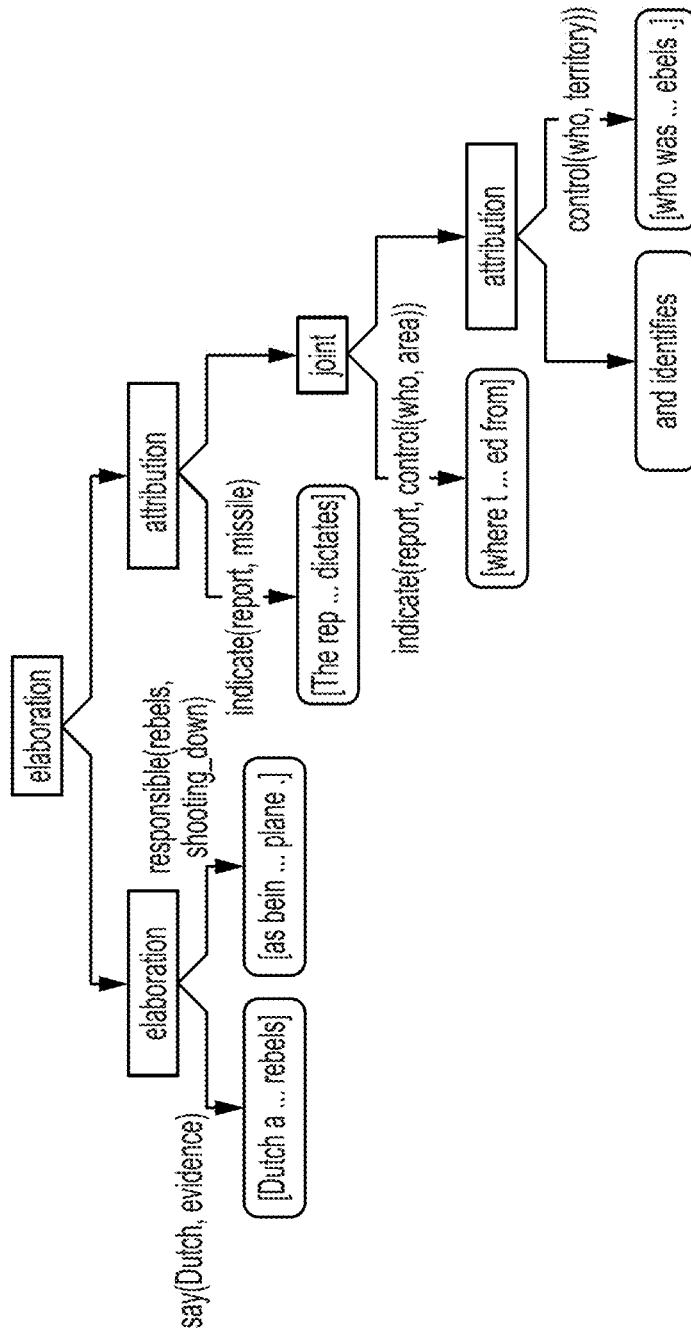

FIG. 11

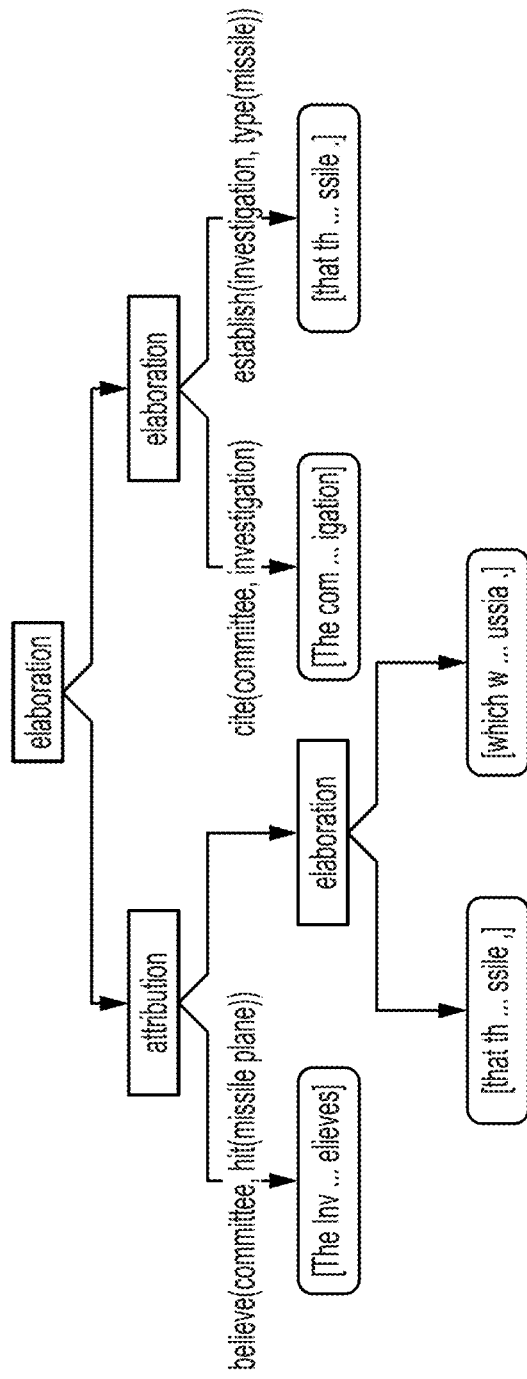

FIG. 12

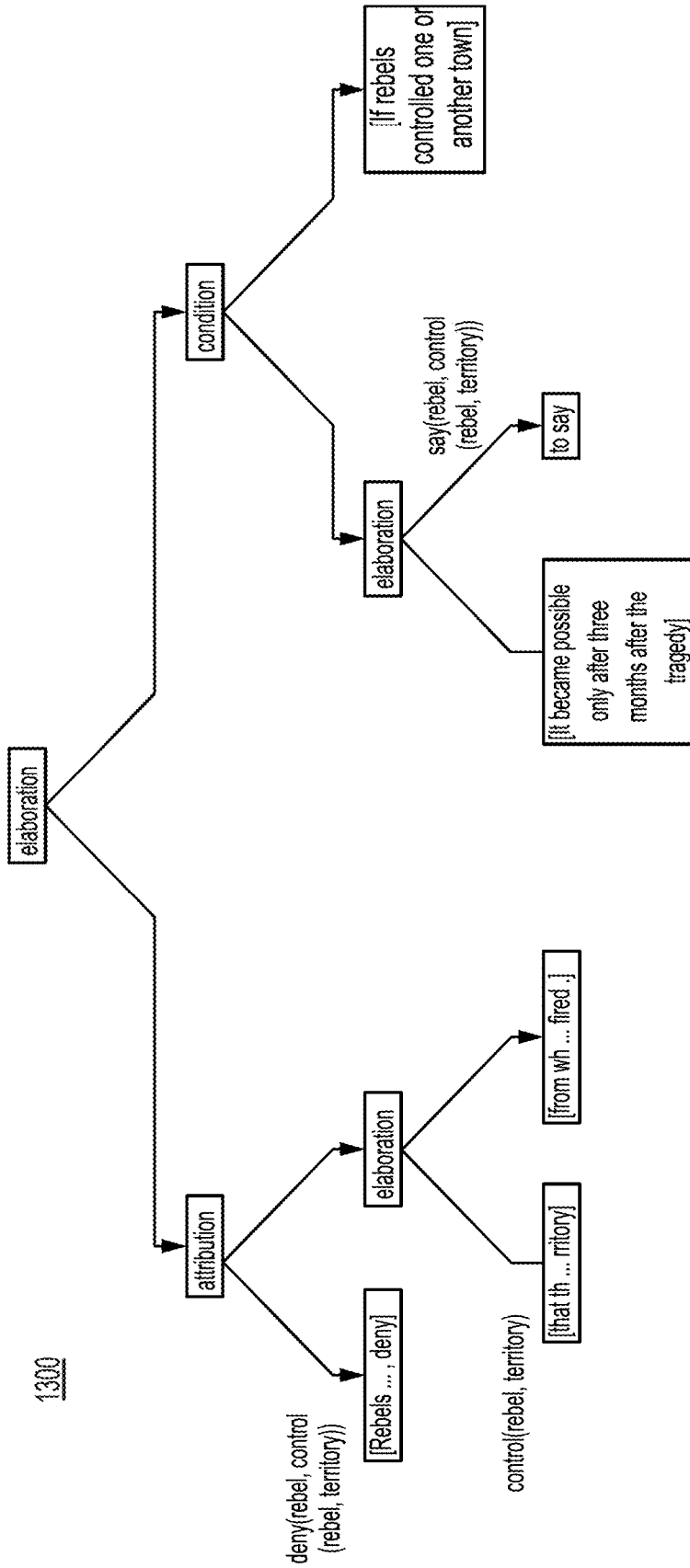

FIG. 13

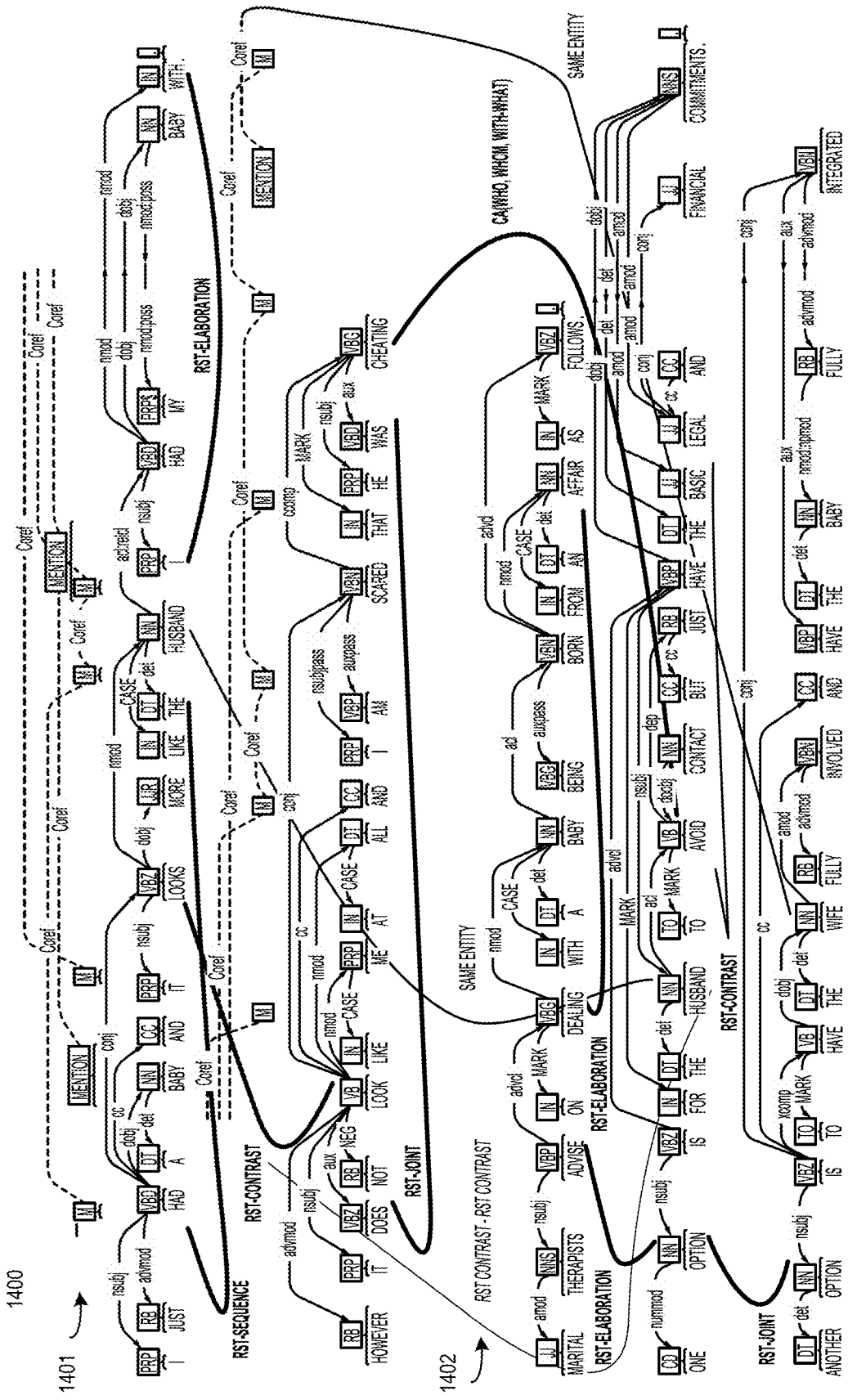

FIG. 14

1500

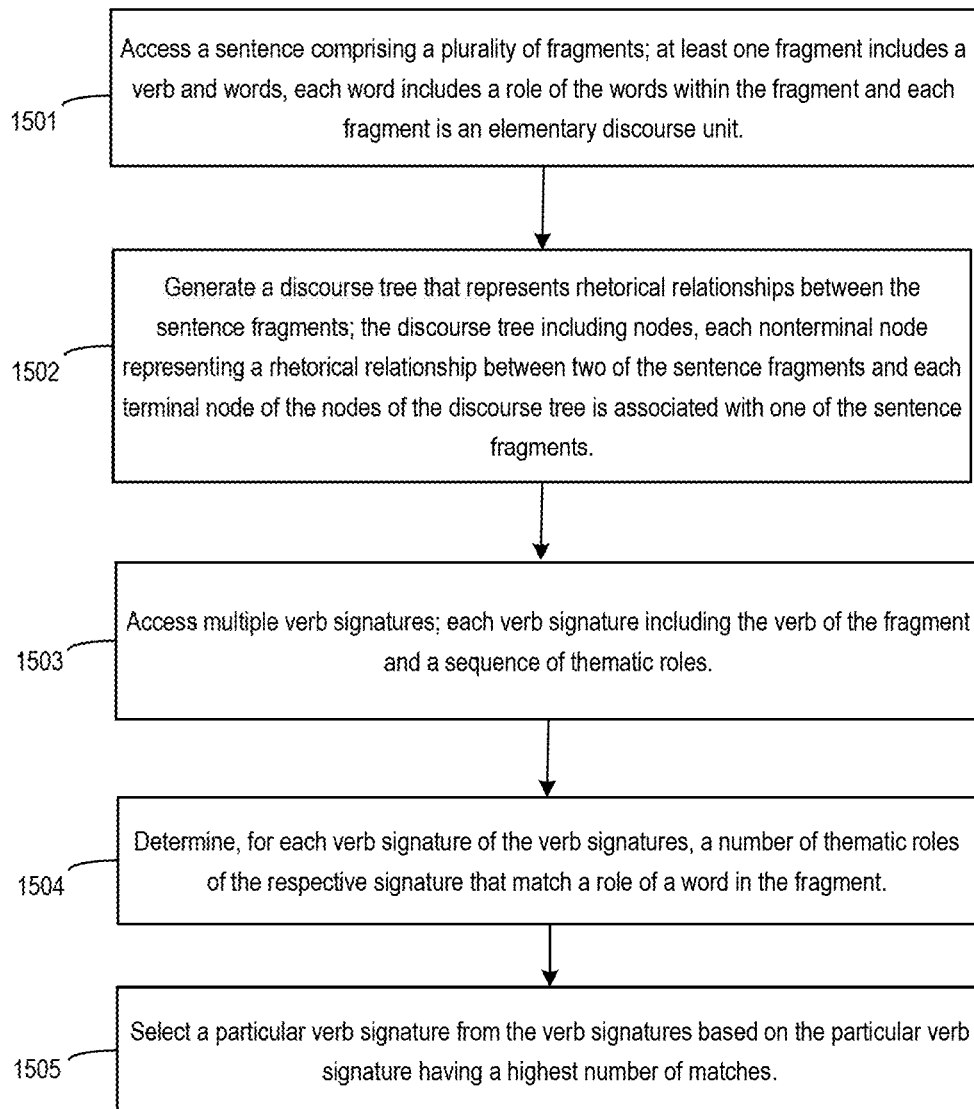

FIG. 15



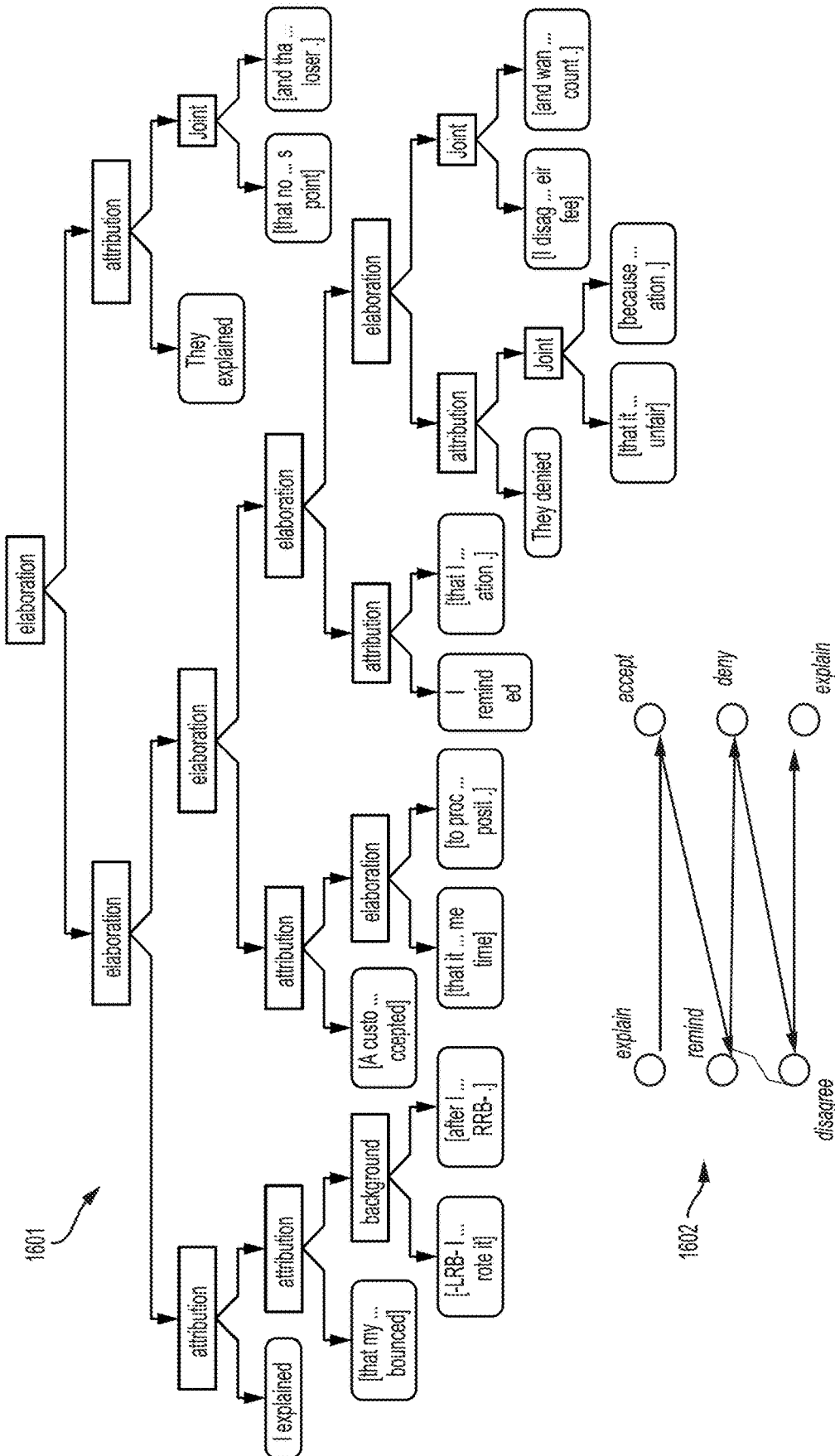

FIG. 16

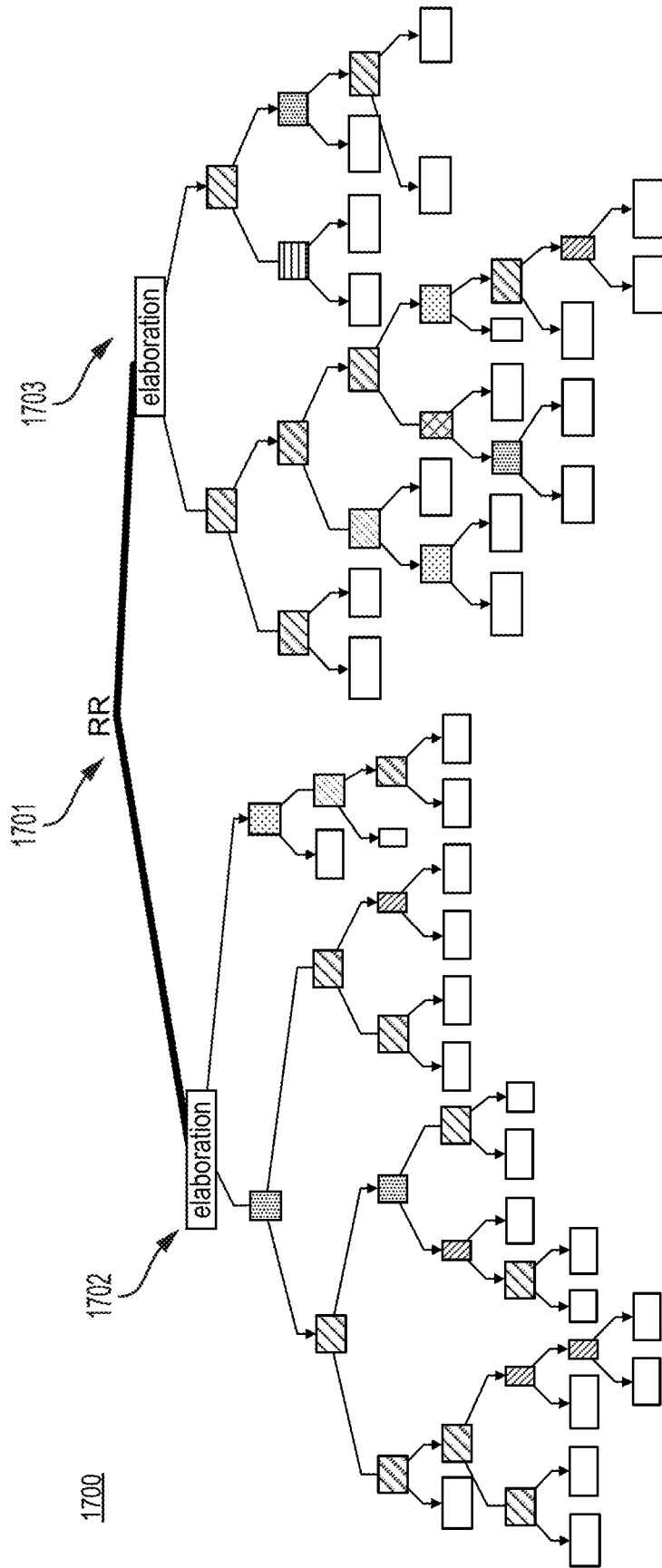

FIG. 17

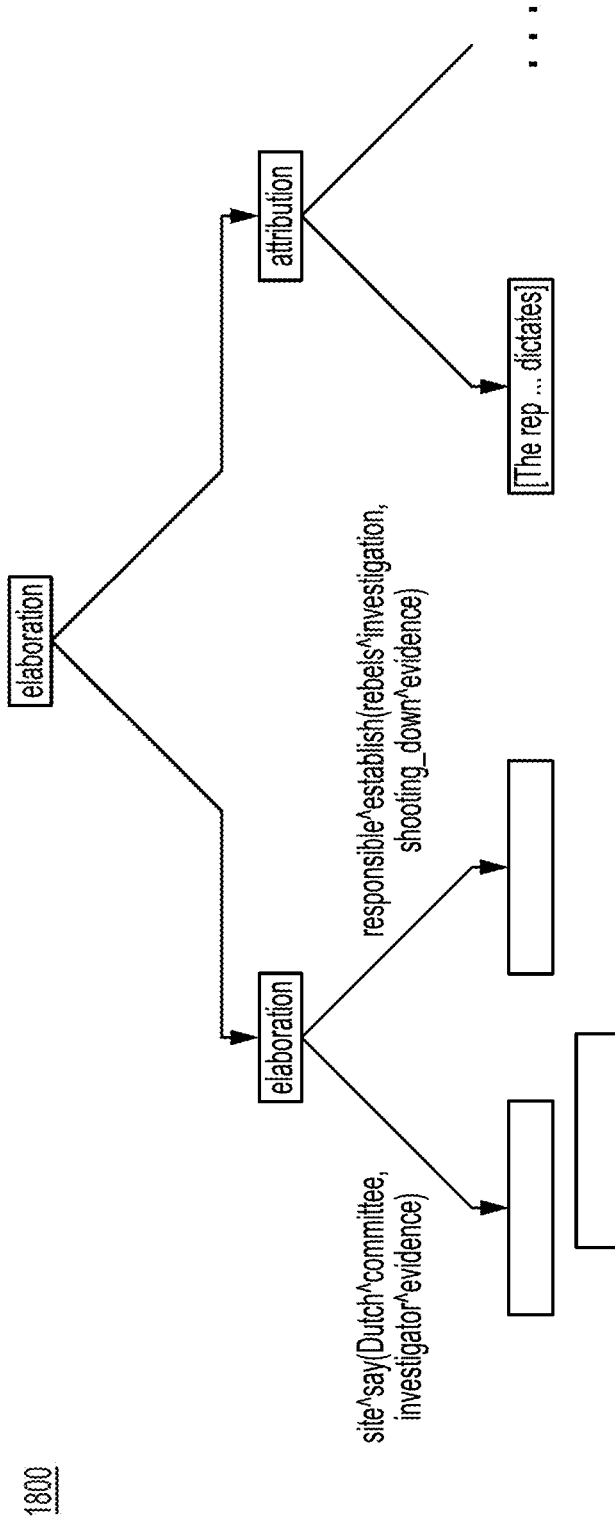

FIG. 18

1800

1900

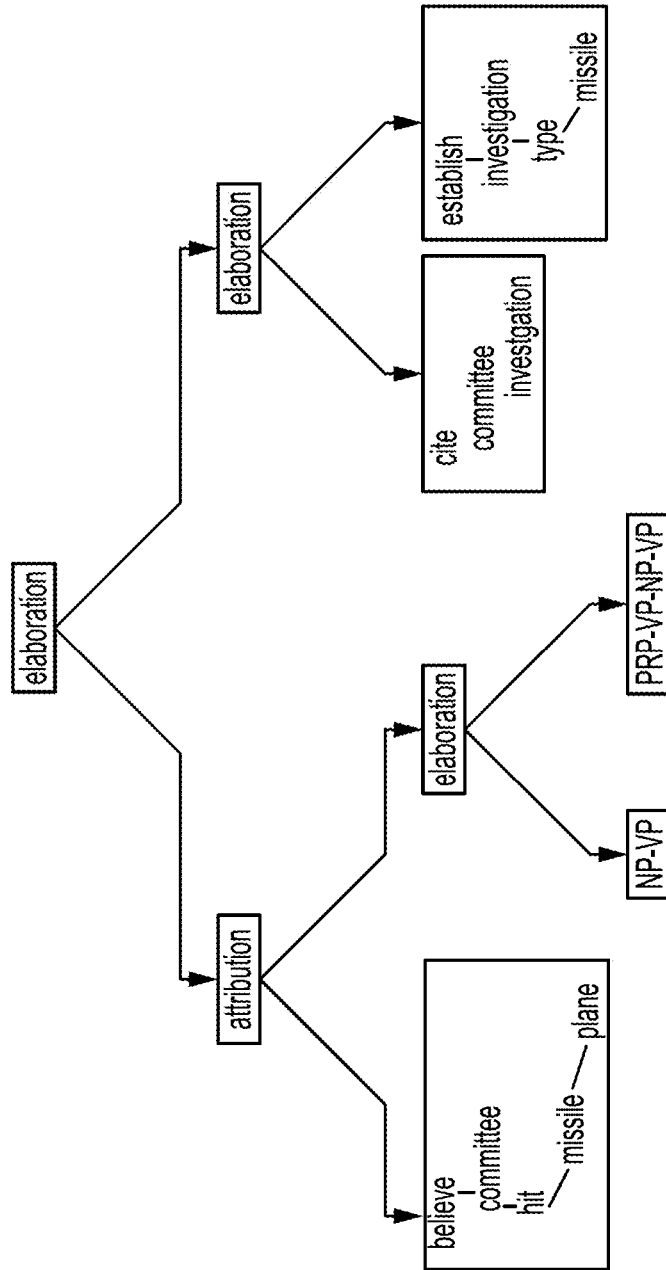

FIG. 19

2000

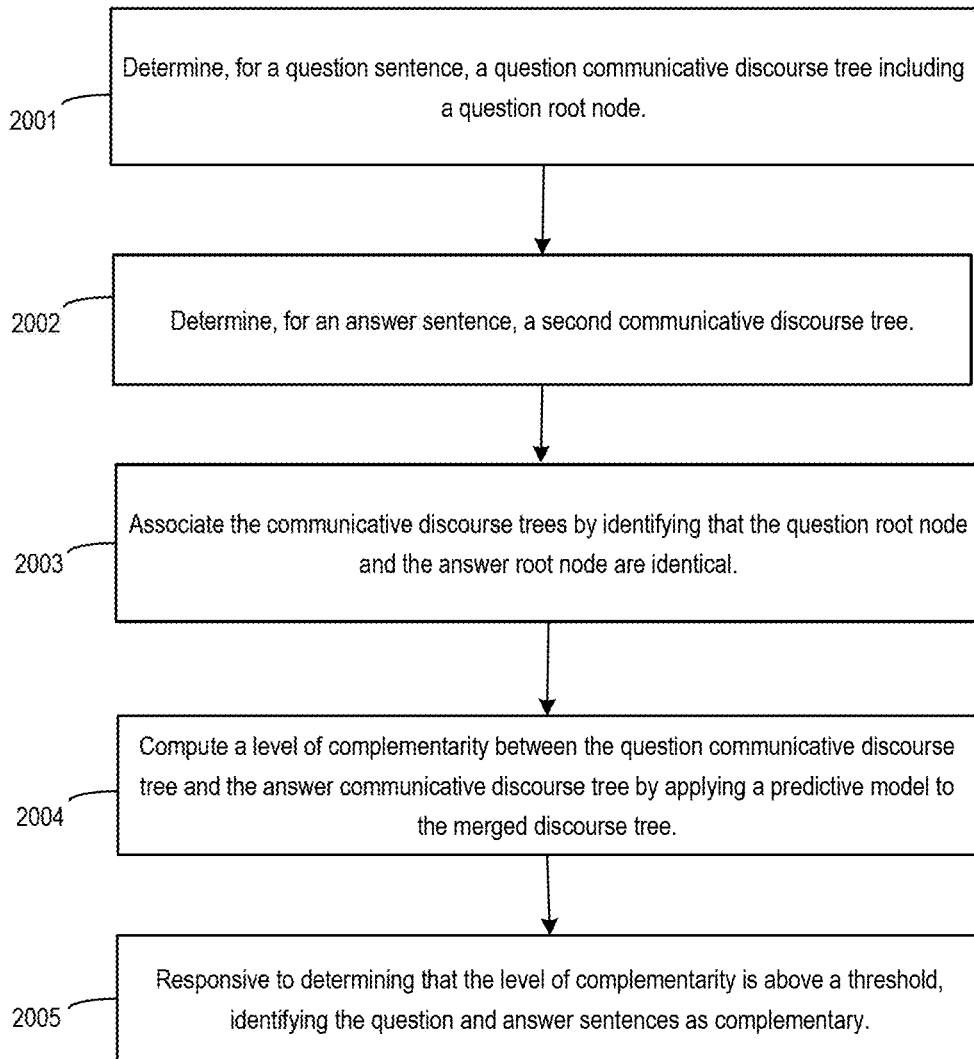

FIG. 20

2100

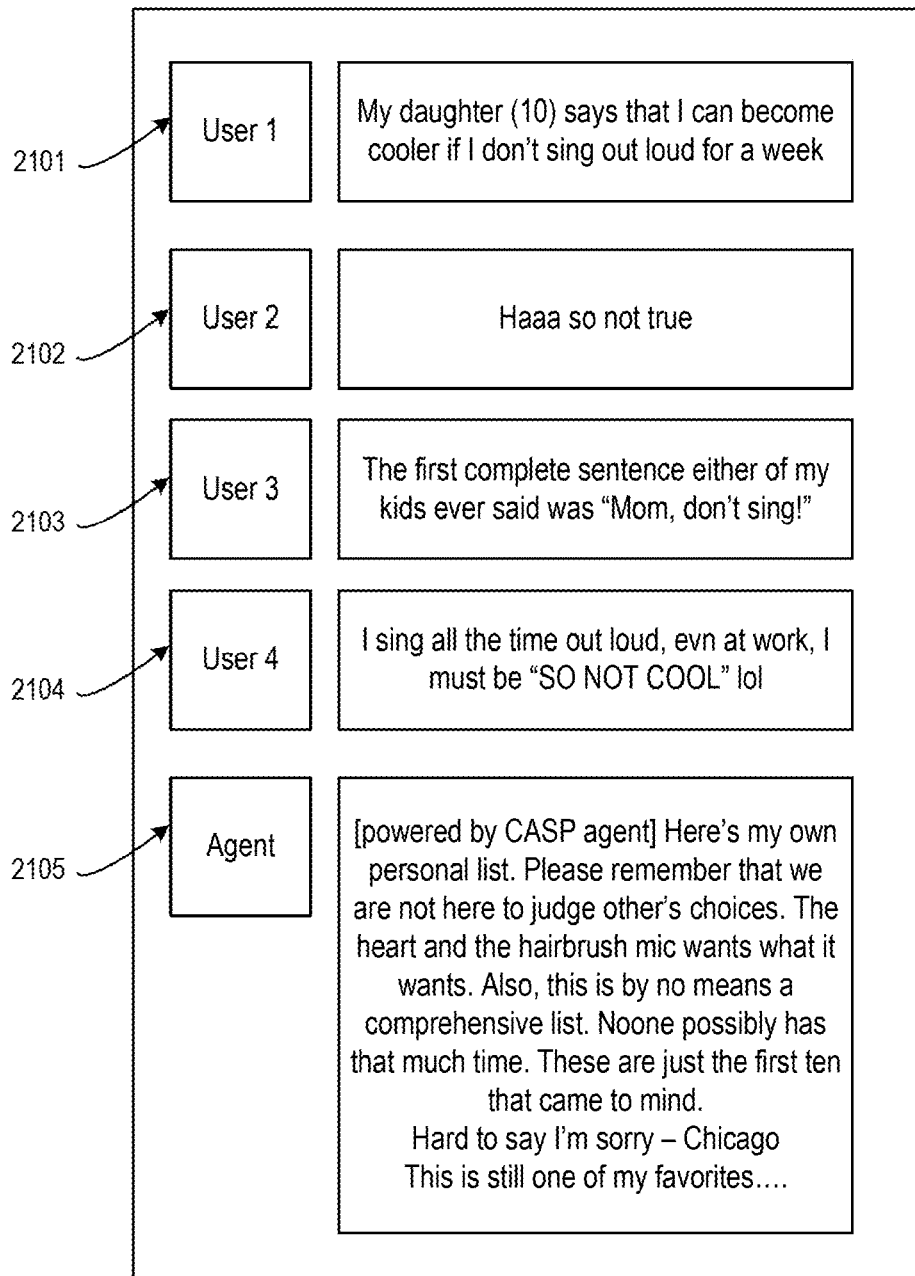

FIG. 21

2200

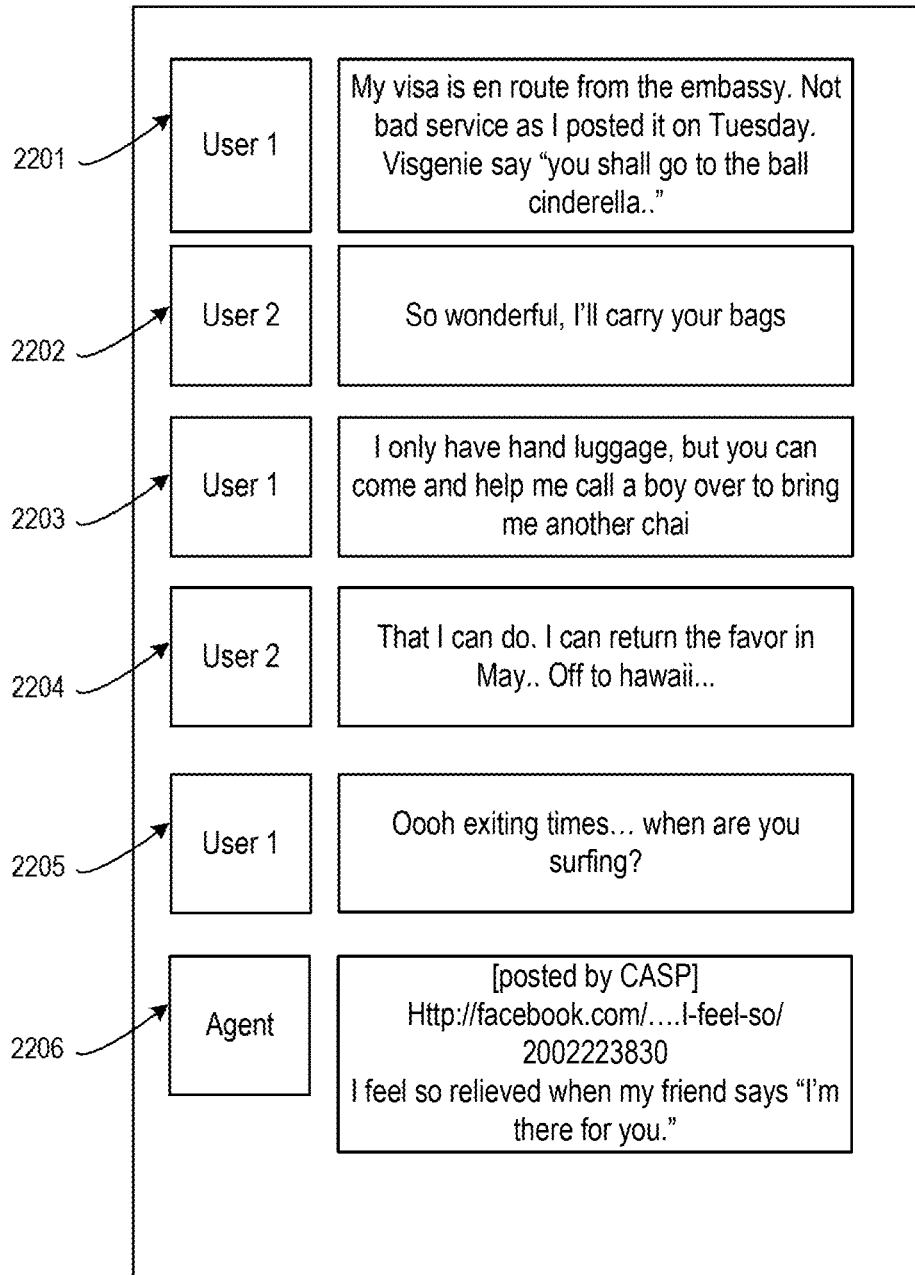

FIG. 22

2300

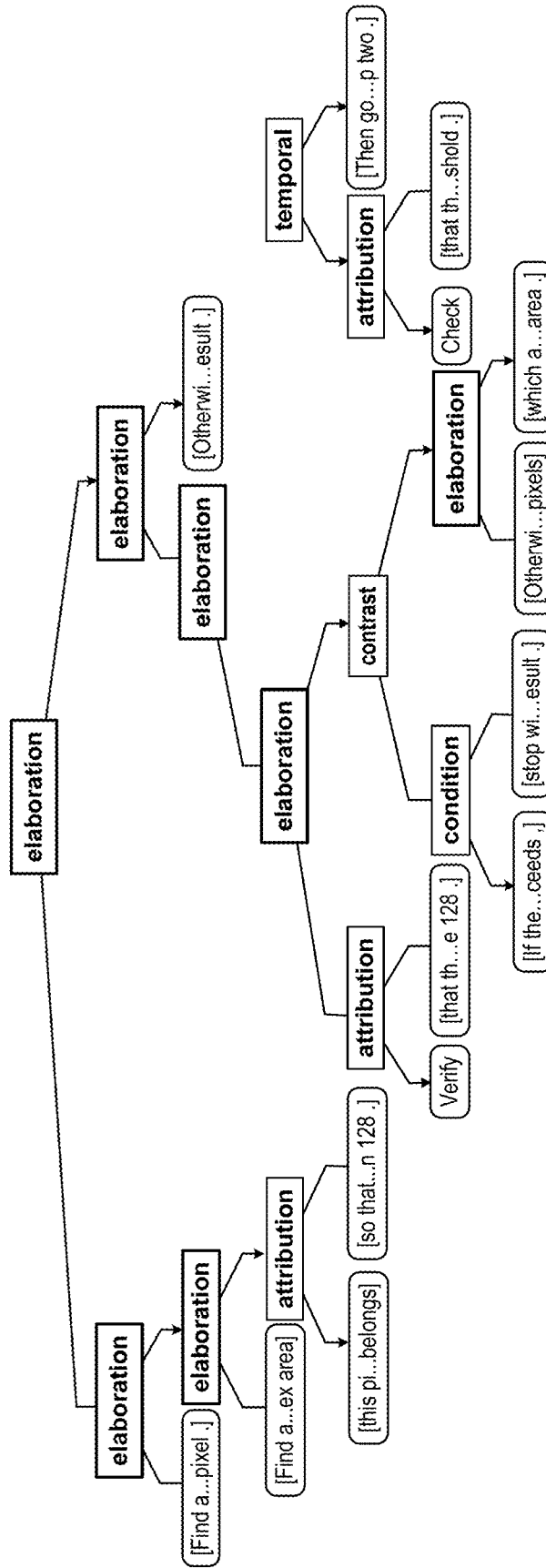

FIG. 23



2400

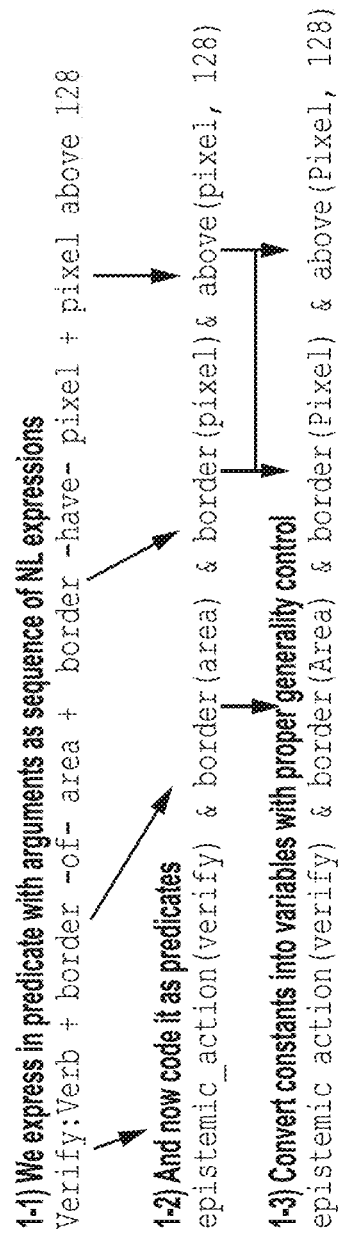

FIG. 24

2500

**1-5) Quantification**  
epistemic action(verify) & border(Area) & not ( border(Pixel) & not  
above(Pixel, 128)) & area(Area)

Loop => Pixel.next()

template for it.

**2-2) Finding code template for specified epistemic action**

```
Bool b0n=true;
while (!(ObjectToTest.next()==null)) {
if !(Conditions) {
b0n=false;
break;}
} Return b0n;
```

Finally, we have

**2-3) Resultant code fragment**

```
while (!(Pixel.next()==null)) {
if !(border.belong(Pixel) && Pixel.above(128)){
b0n=false;
break;}
}
Return b0n;
```

FIG. 25

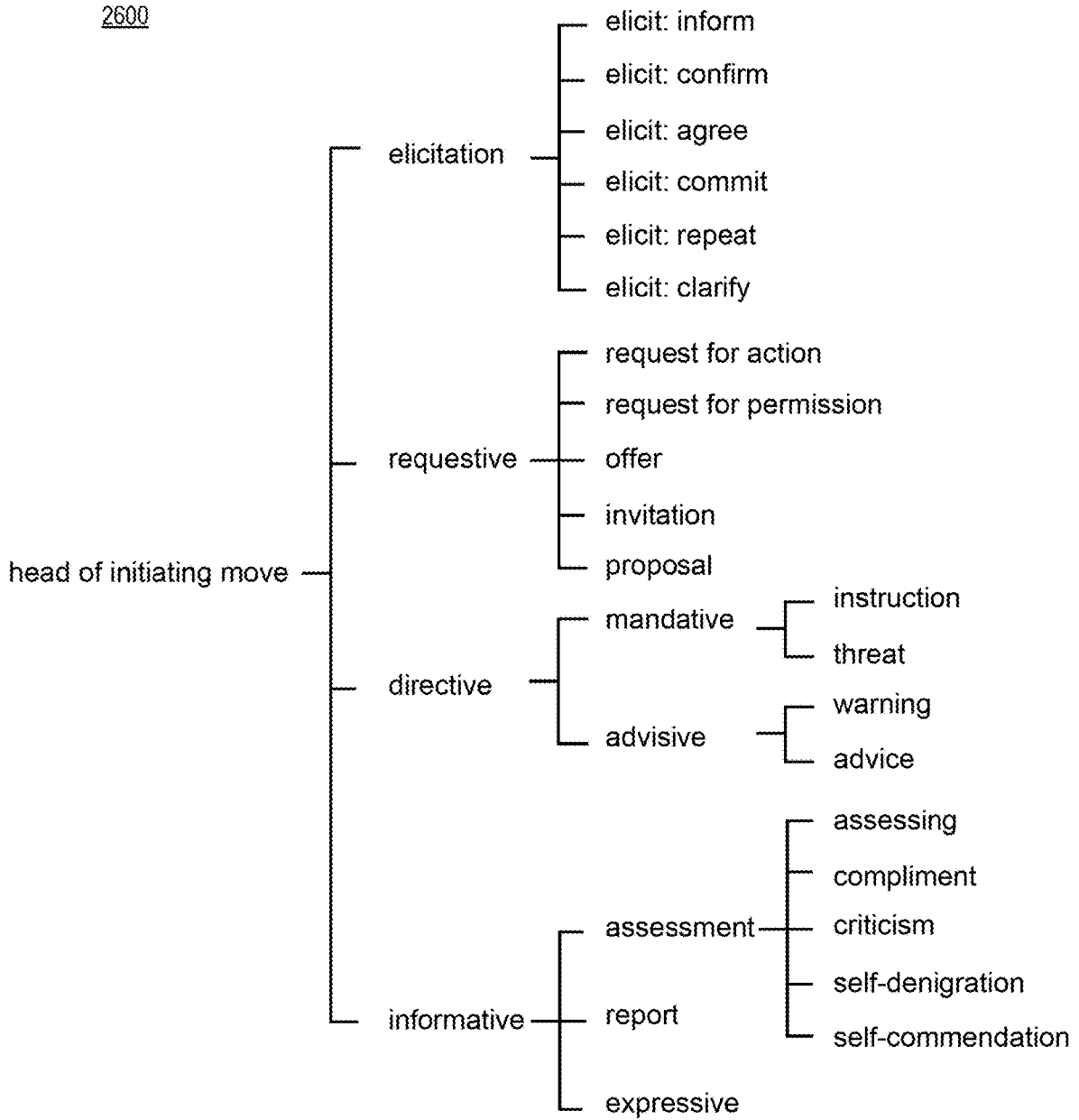

Discourse acts of a dialogue (from Schiffrin 2005)

FIG. 26

2700

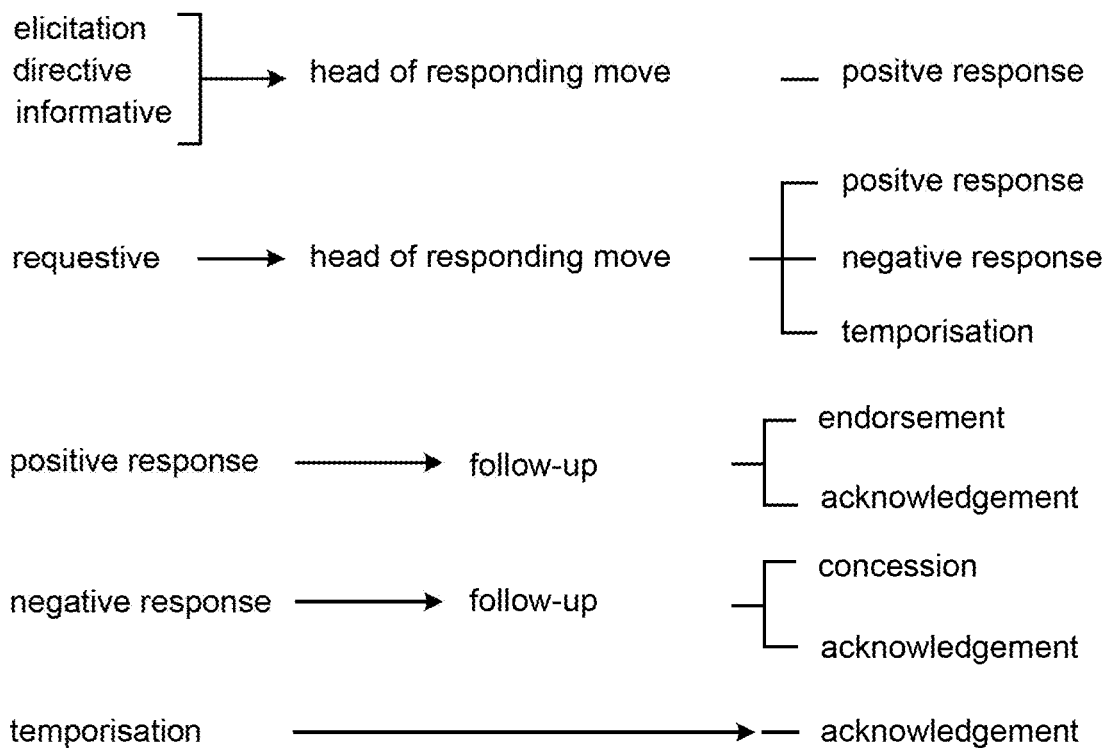

Discourse acts of a dialogue (from Schiffrin 2005)

FIG. 27

2800

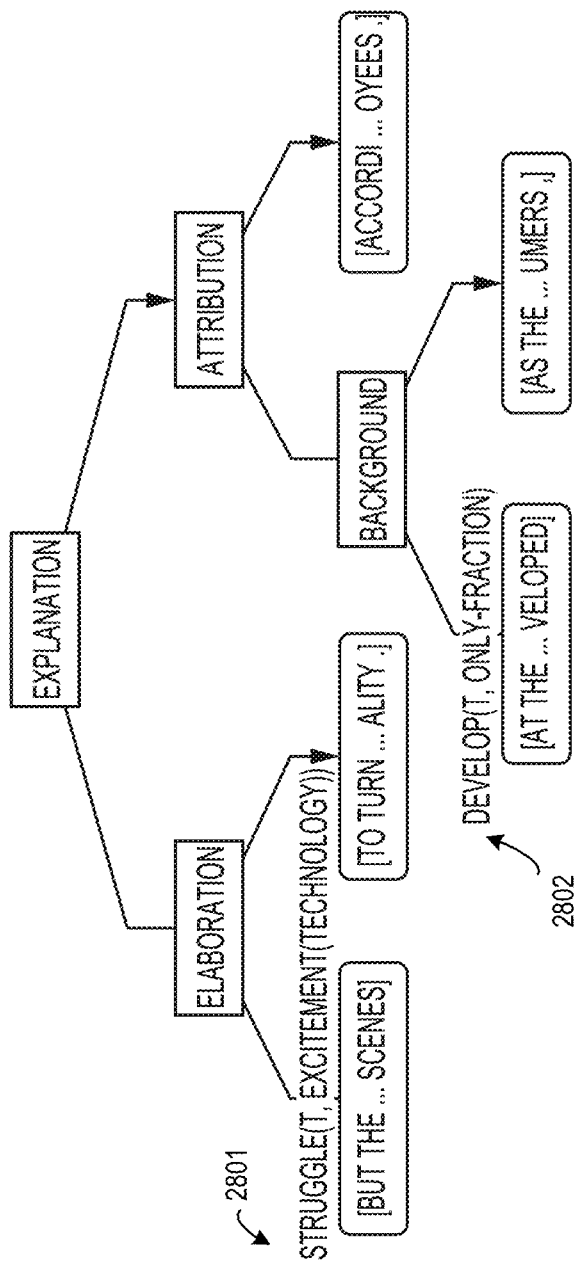

2801

2802

FIG. 28

2900

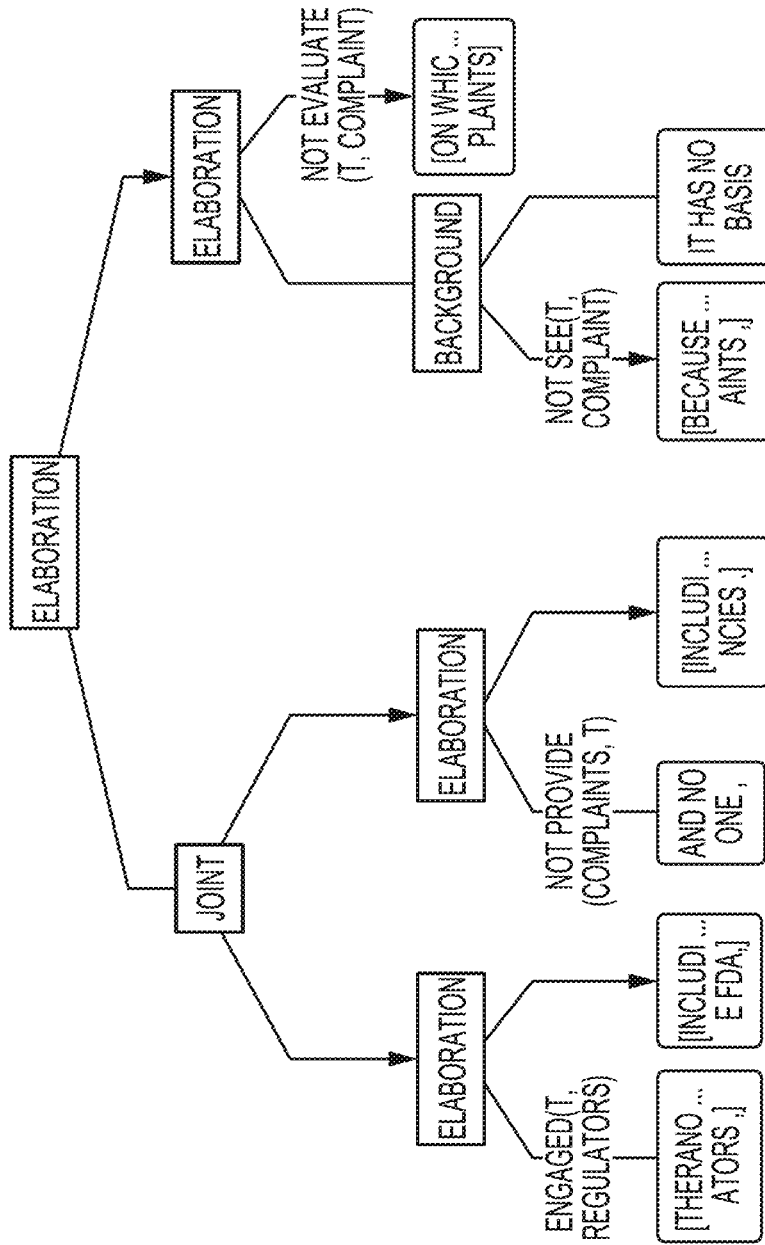

FIG. 29

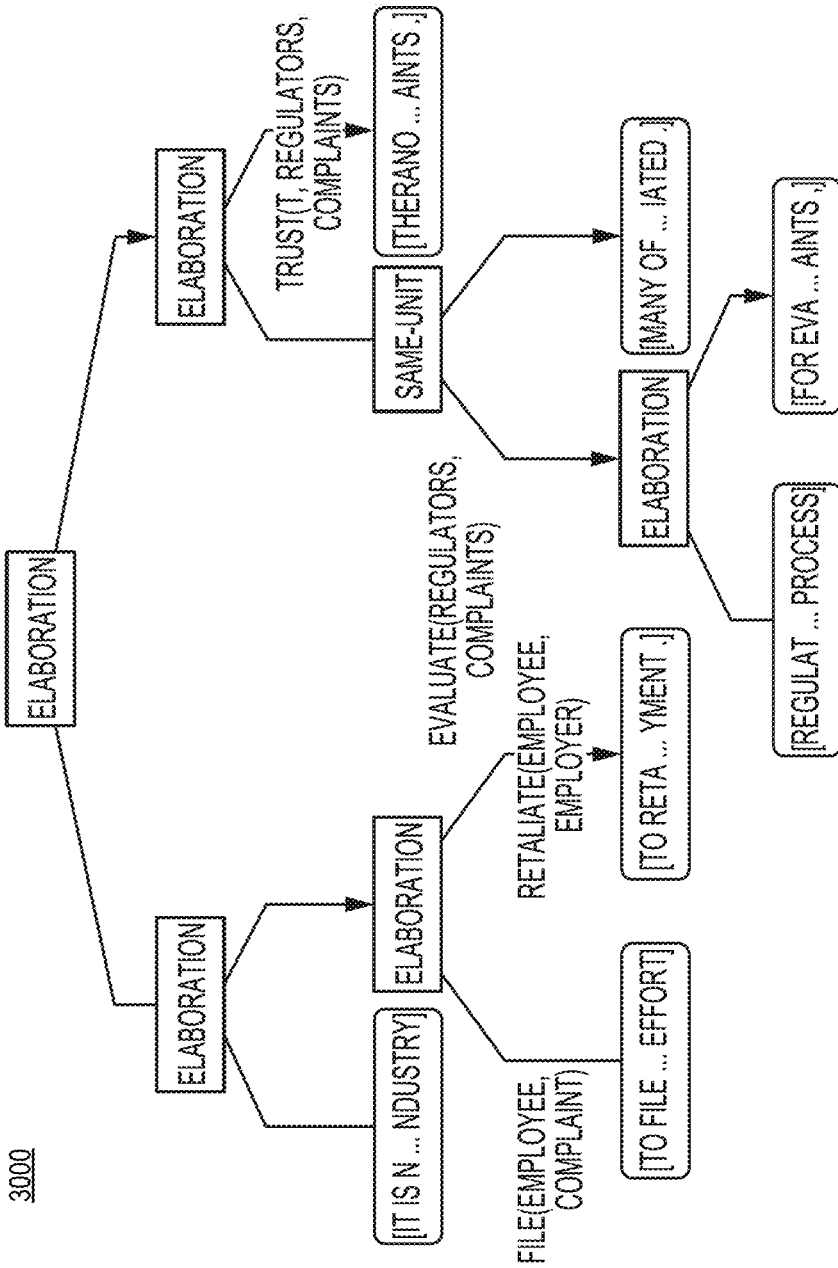

FIG. 30

3100

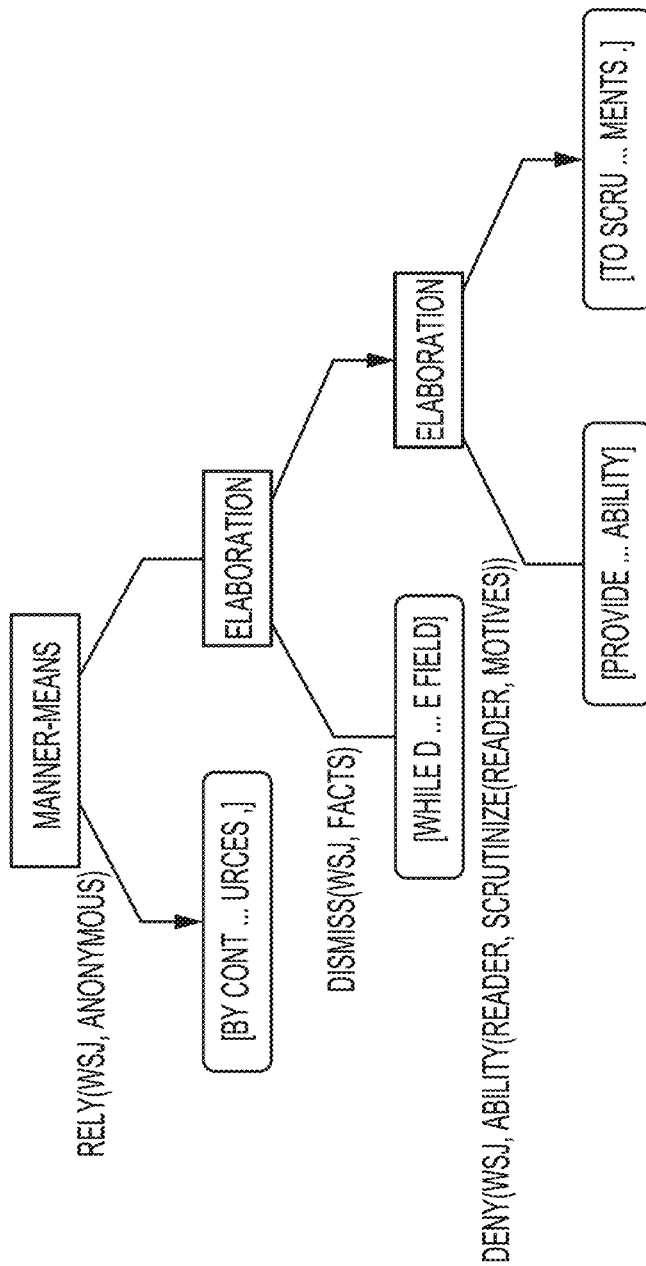

FIG. 31



3200

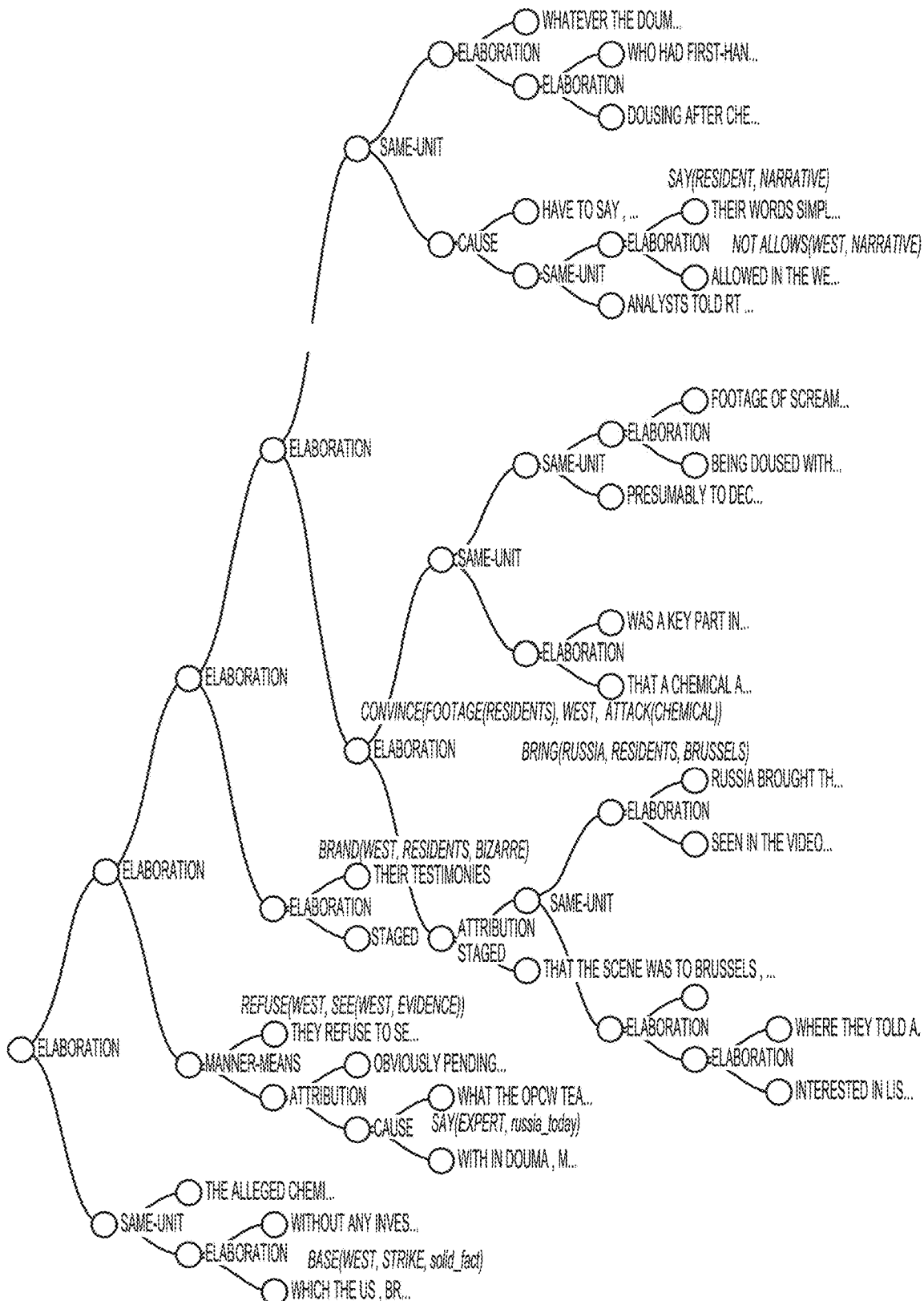

FIG. 32

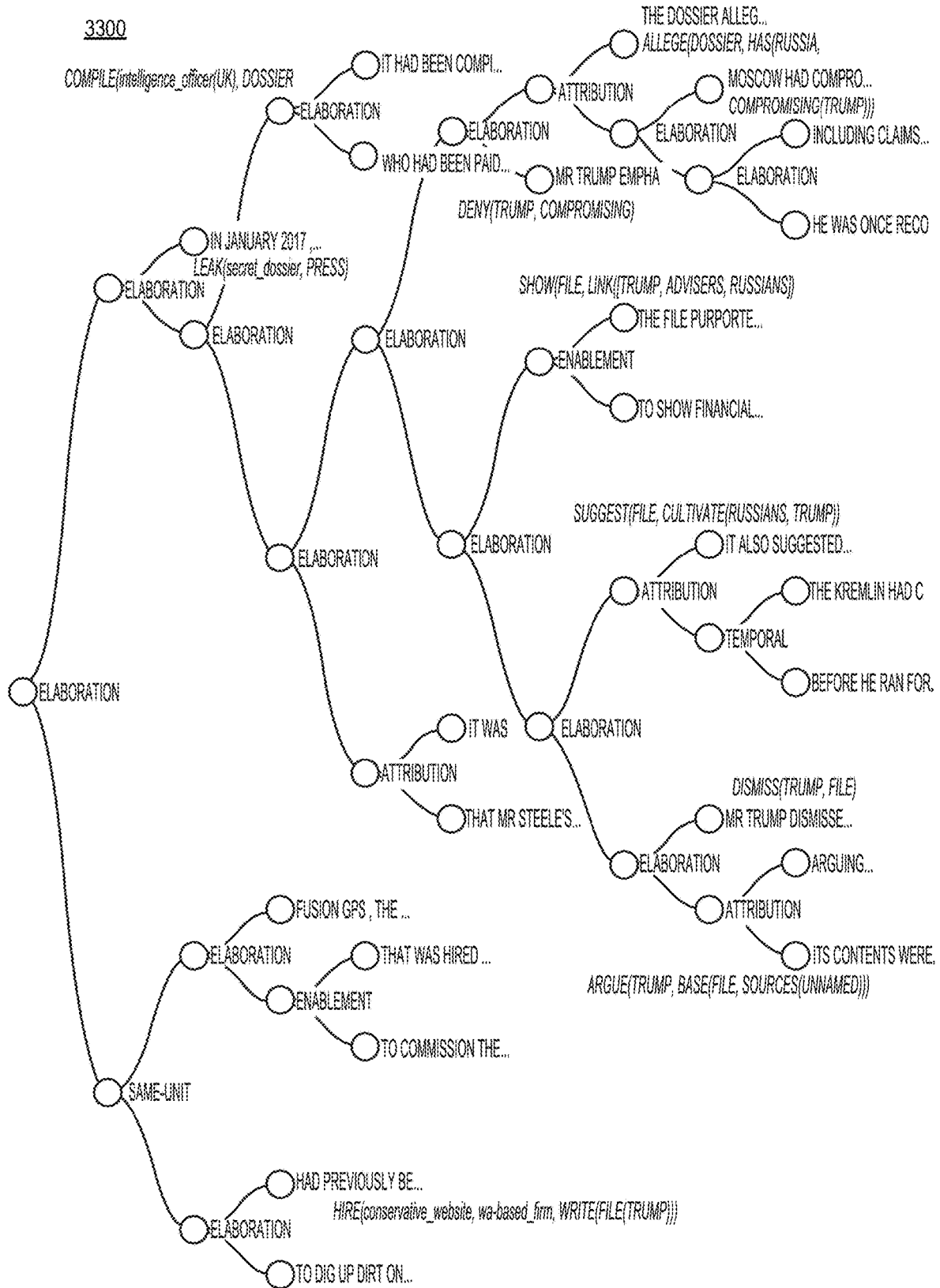

FIG. 33

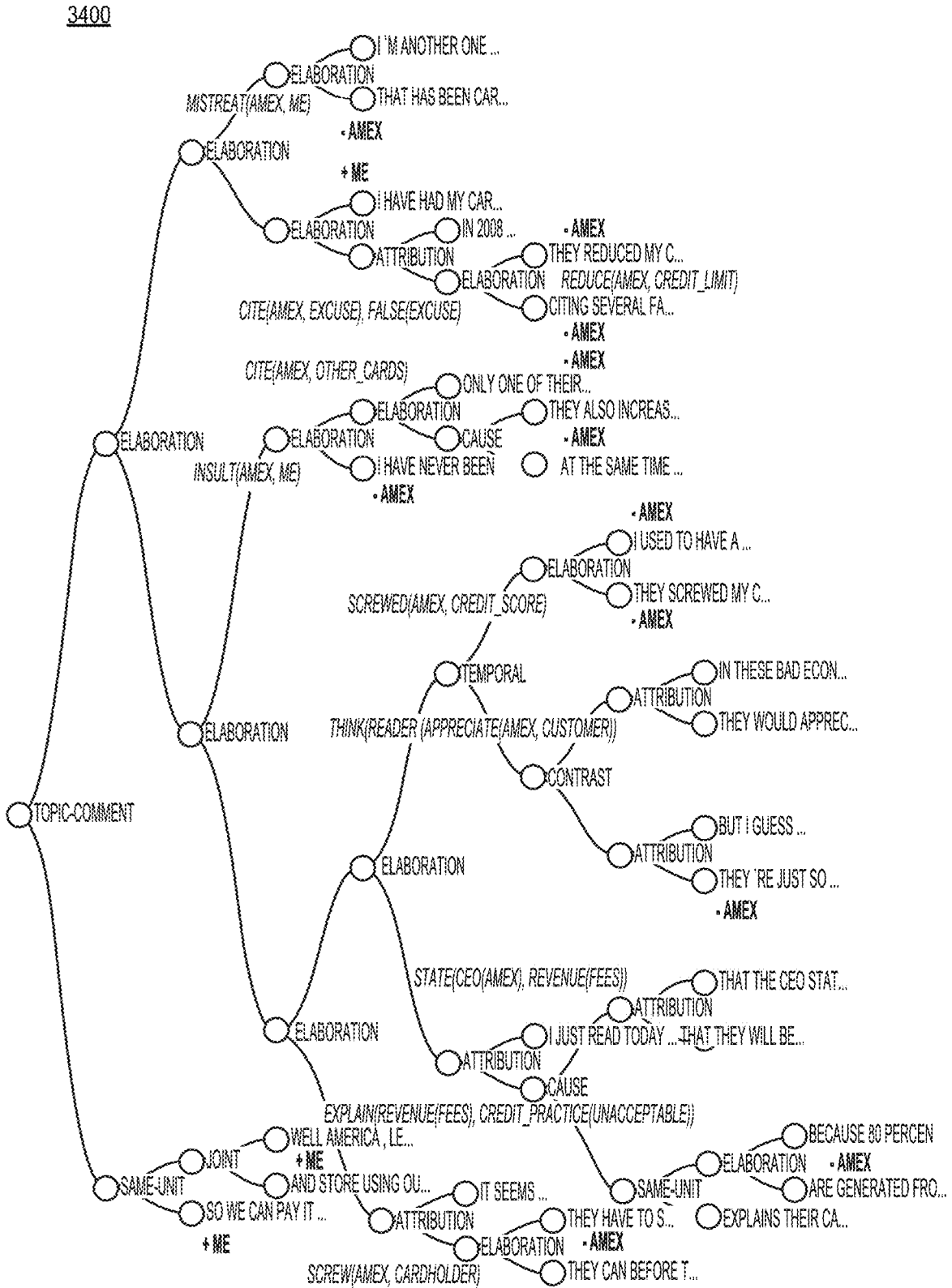

FIG. 34

3500

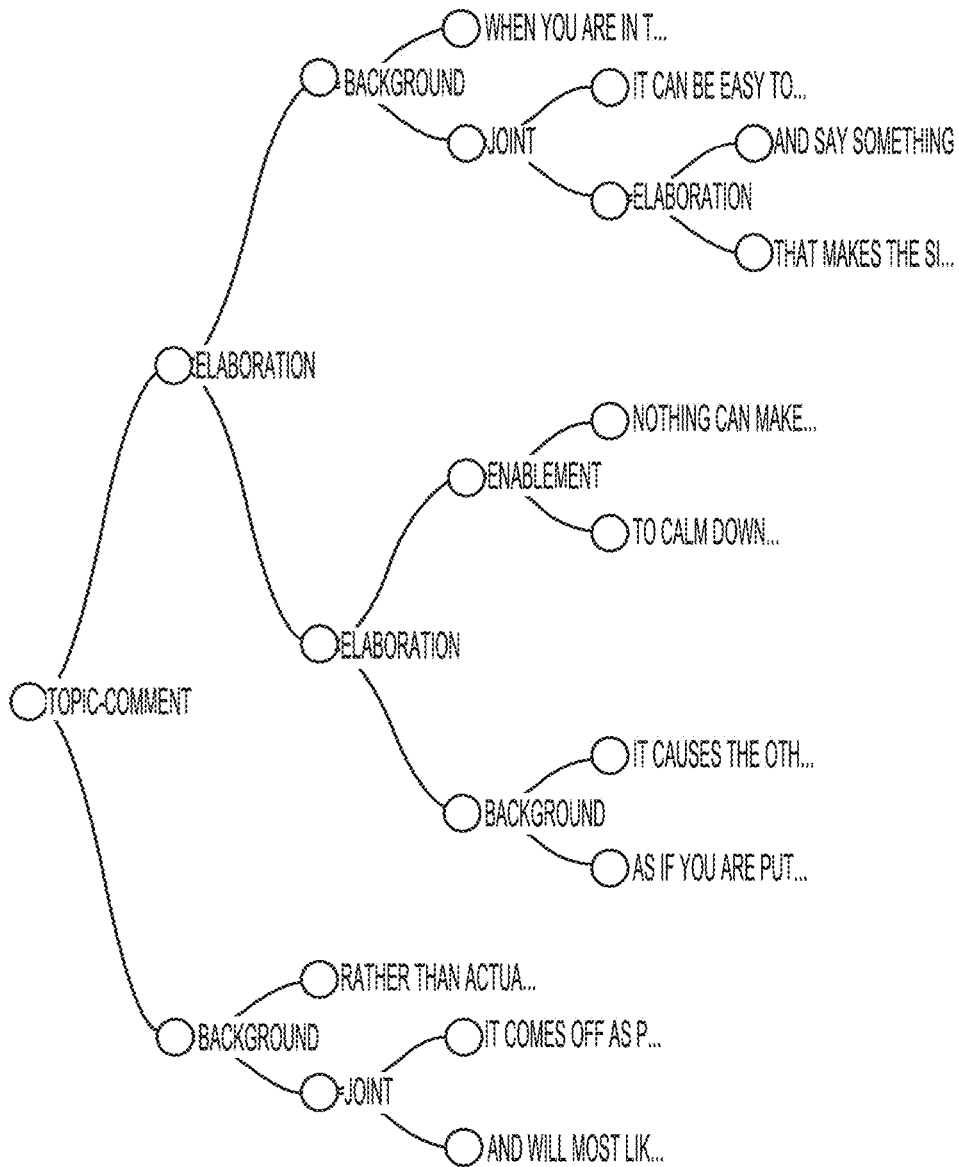

FIG. 35

3600

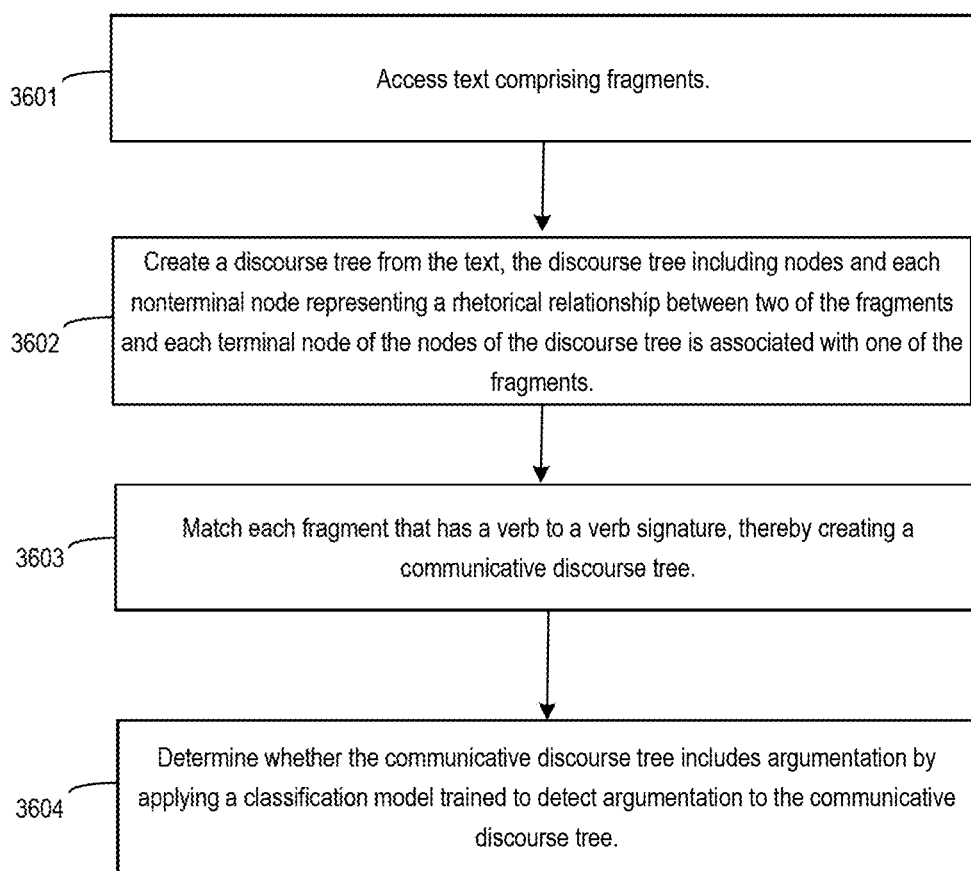

FIG. 36

3700

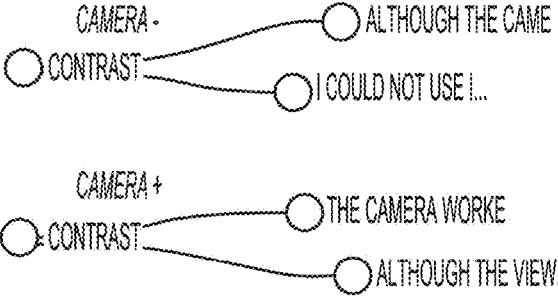

FIG. 37

3800

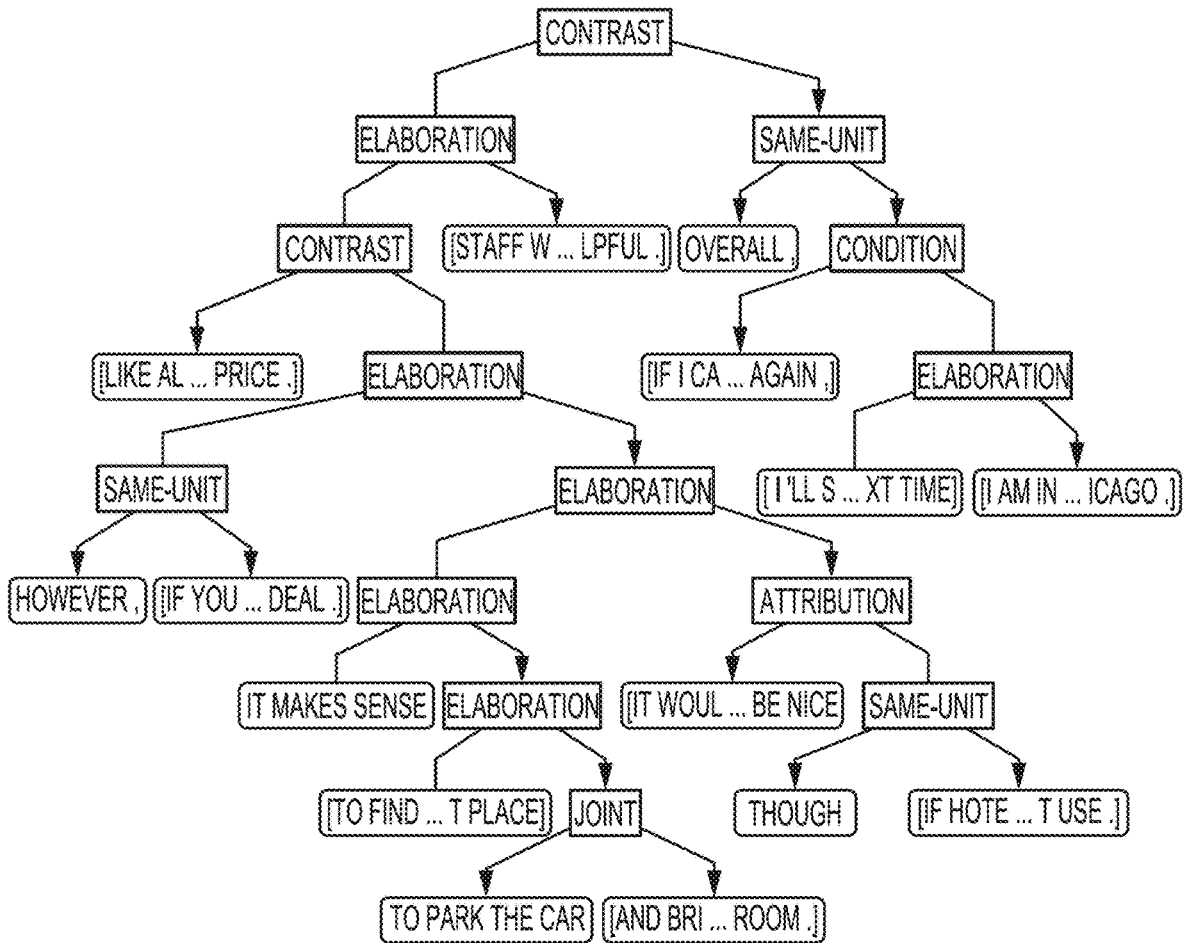

FIG. 38

3900

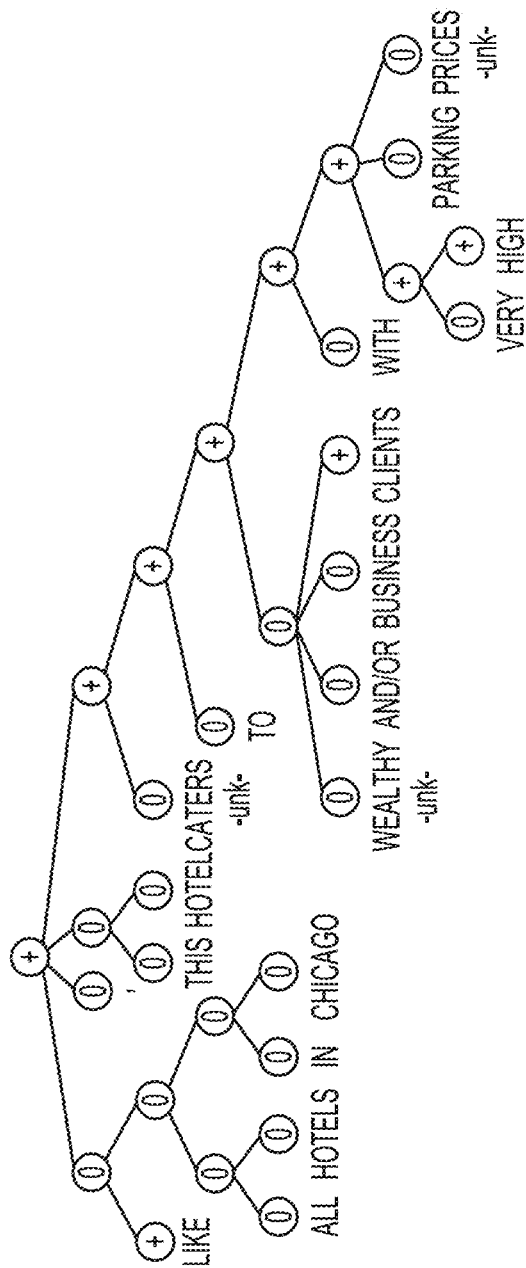

FIG. 39



4000

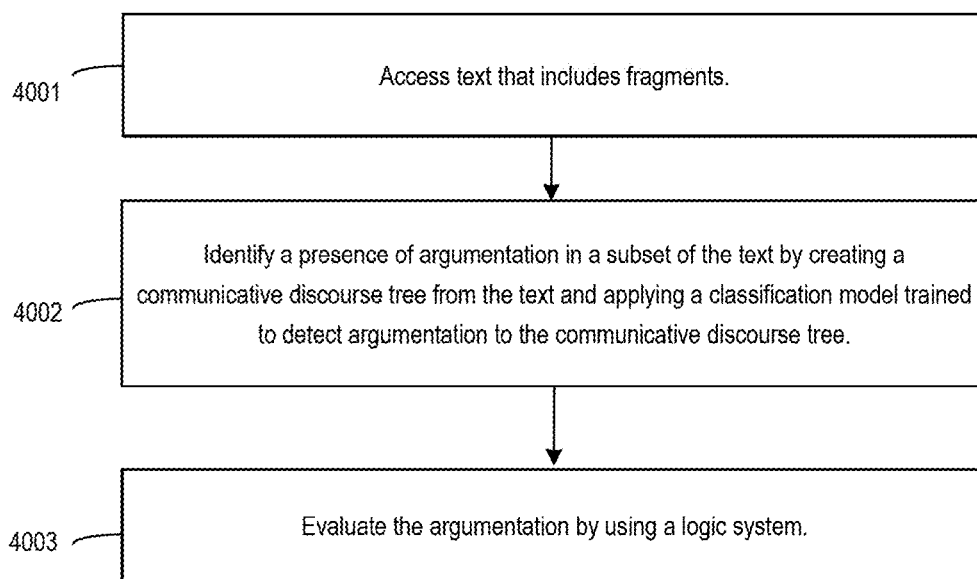

FIG. 40

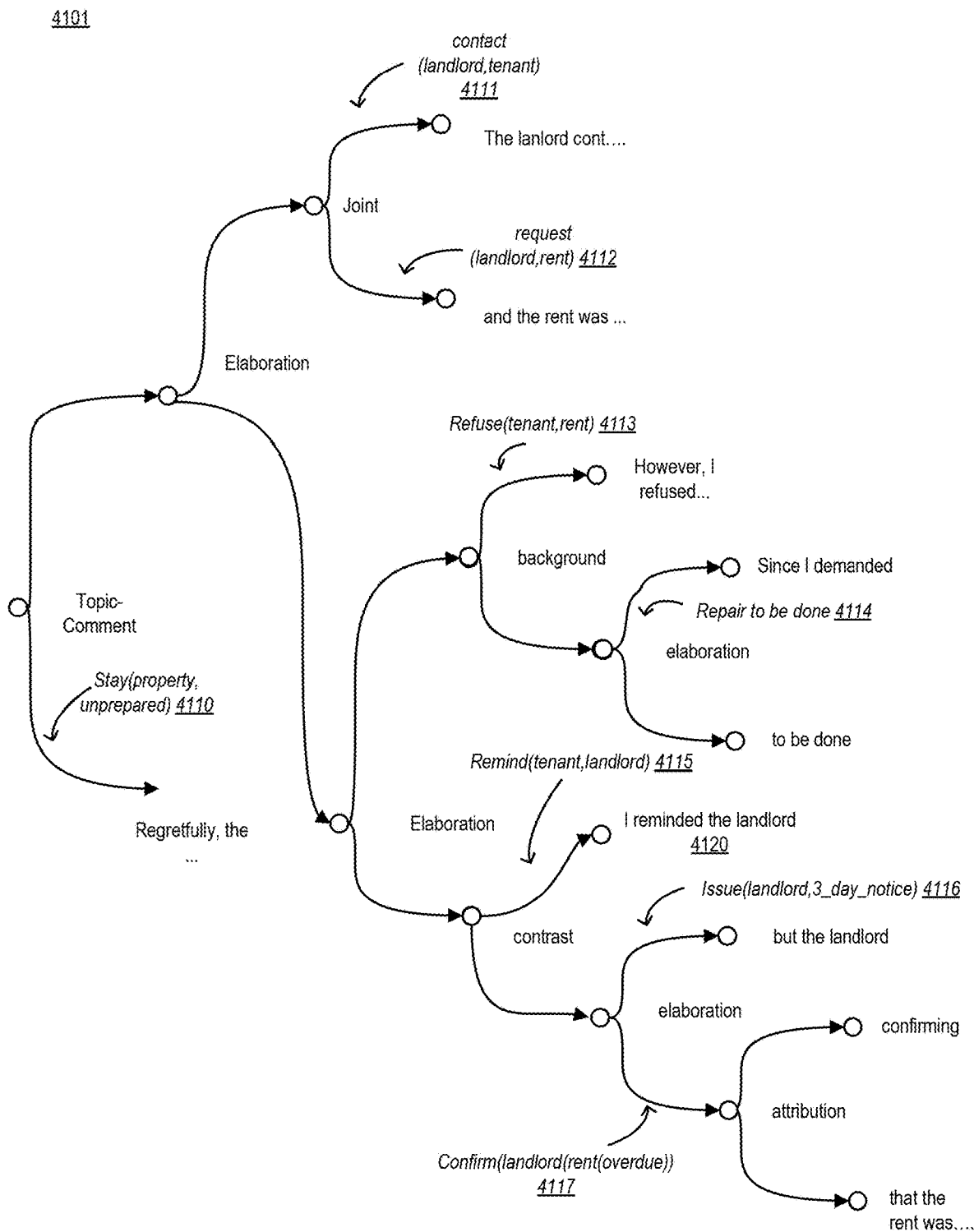

FIG. 41

4200

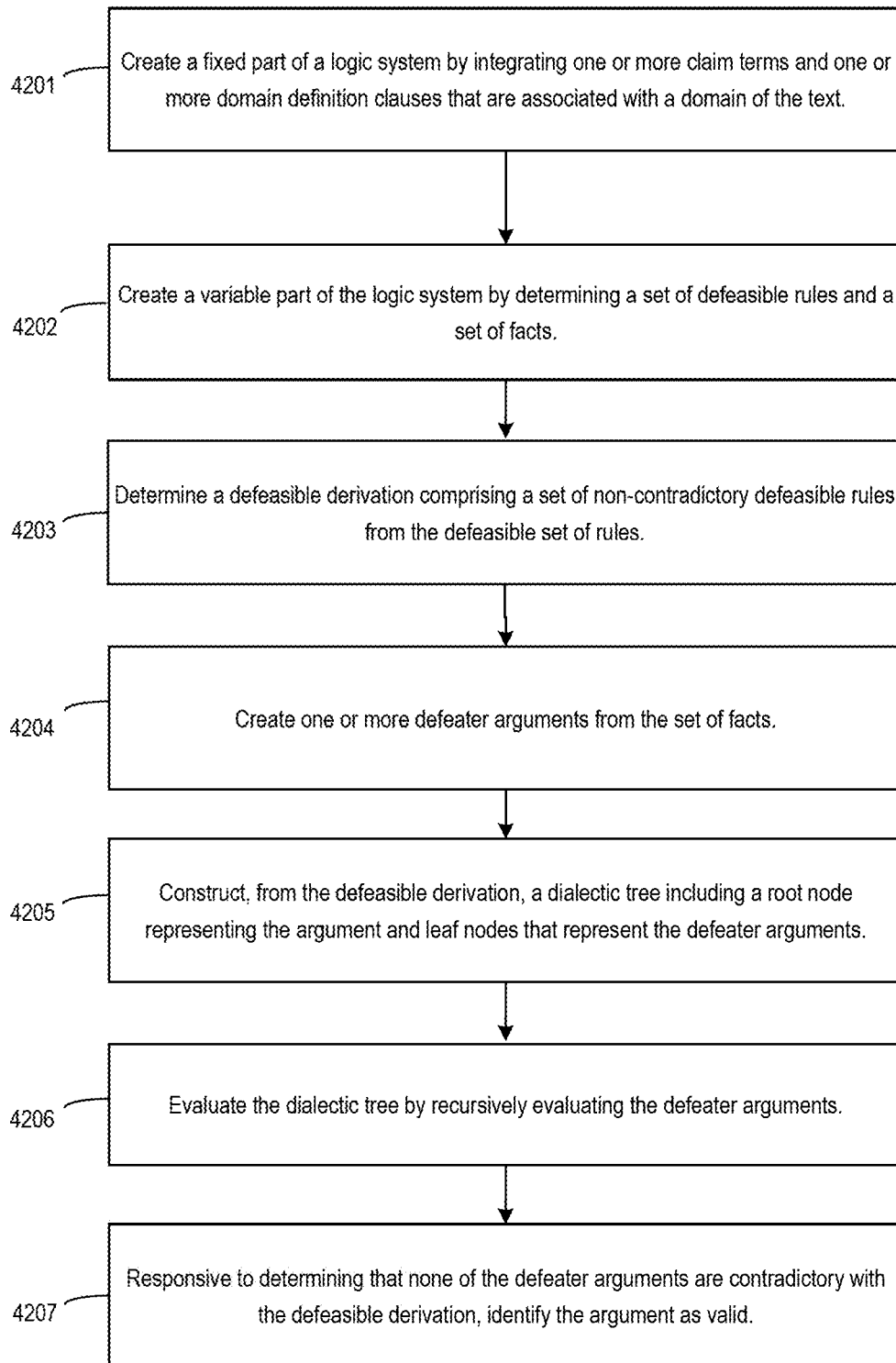

FIG. 42

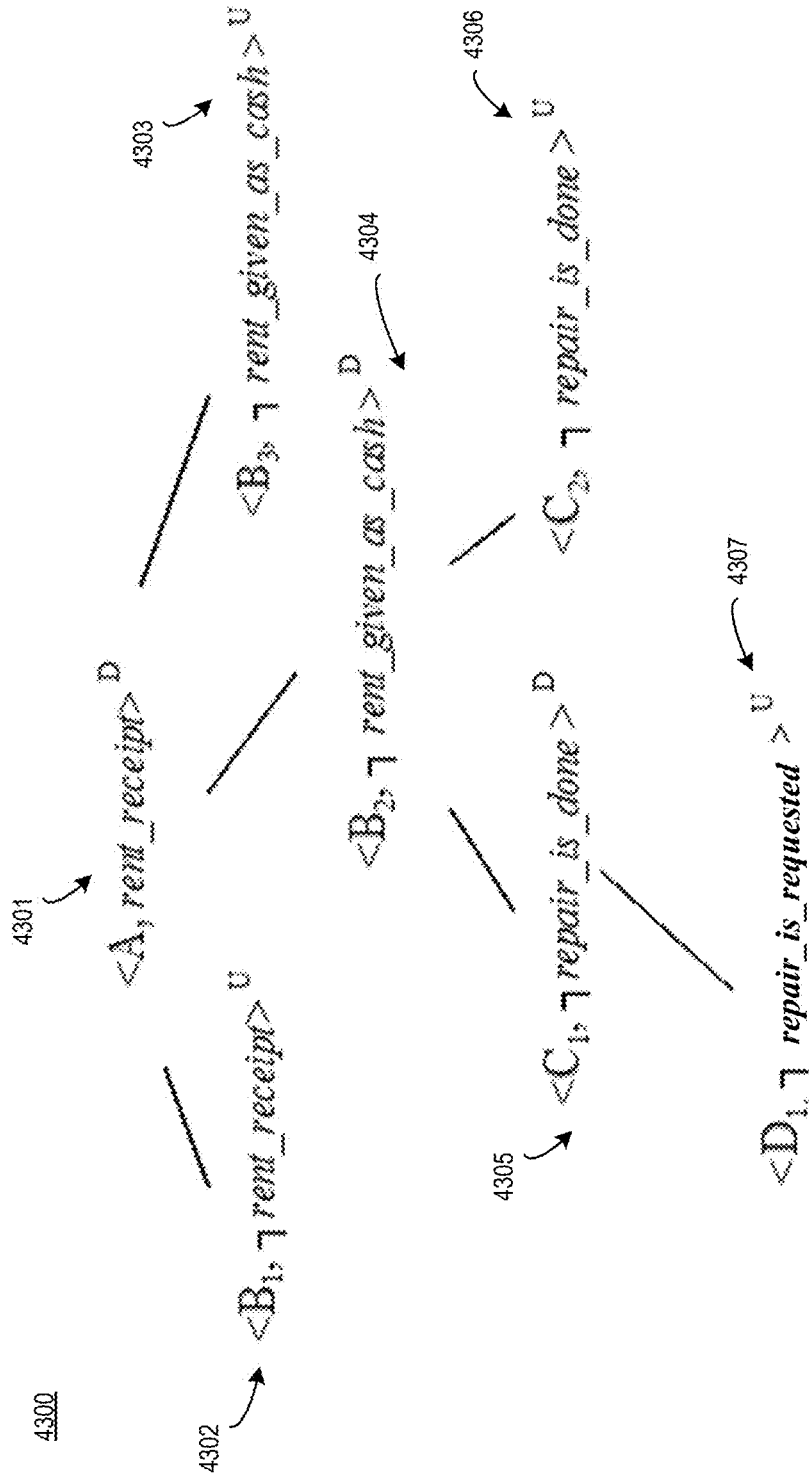

FIG. 43

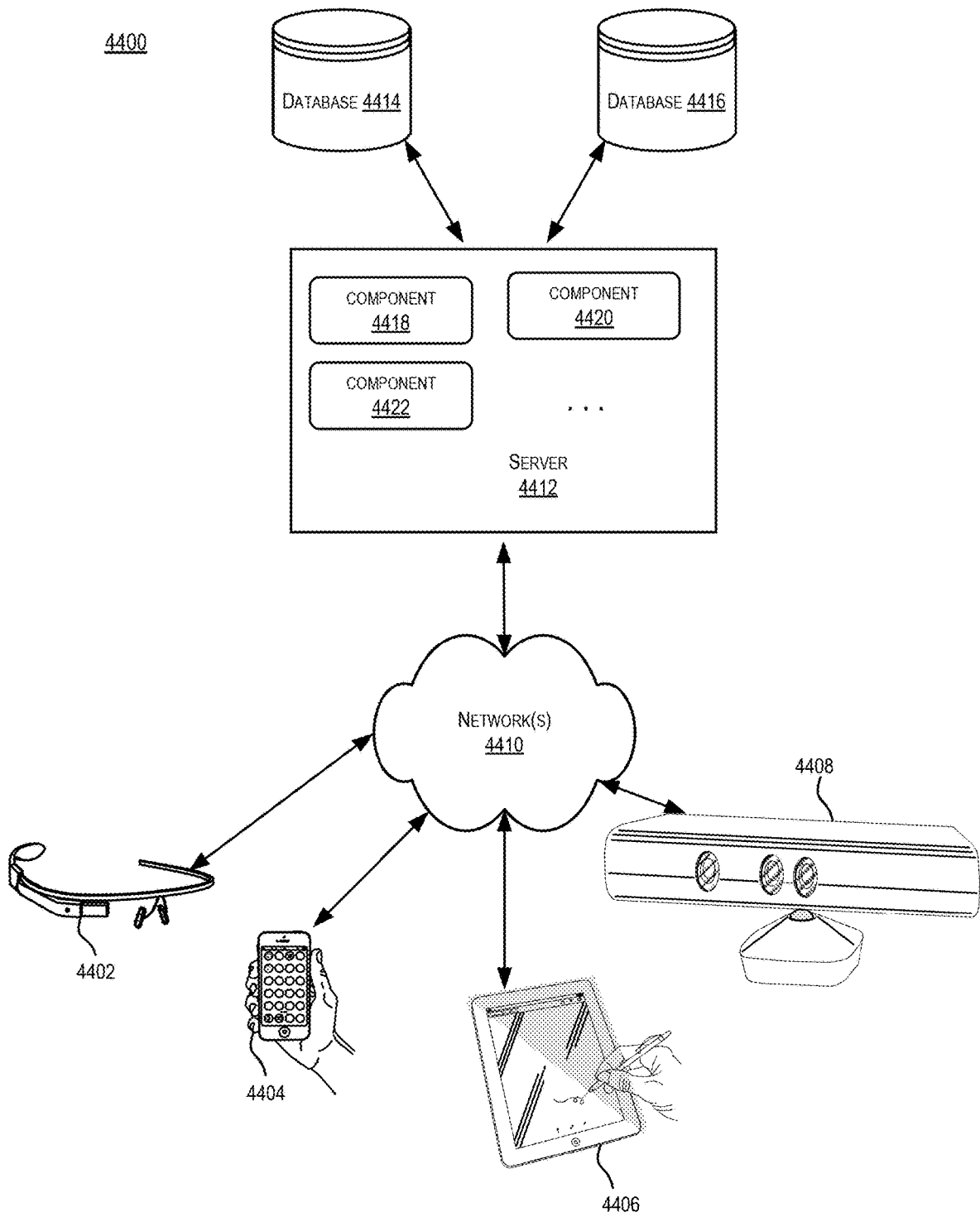

FIG. 44

4500

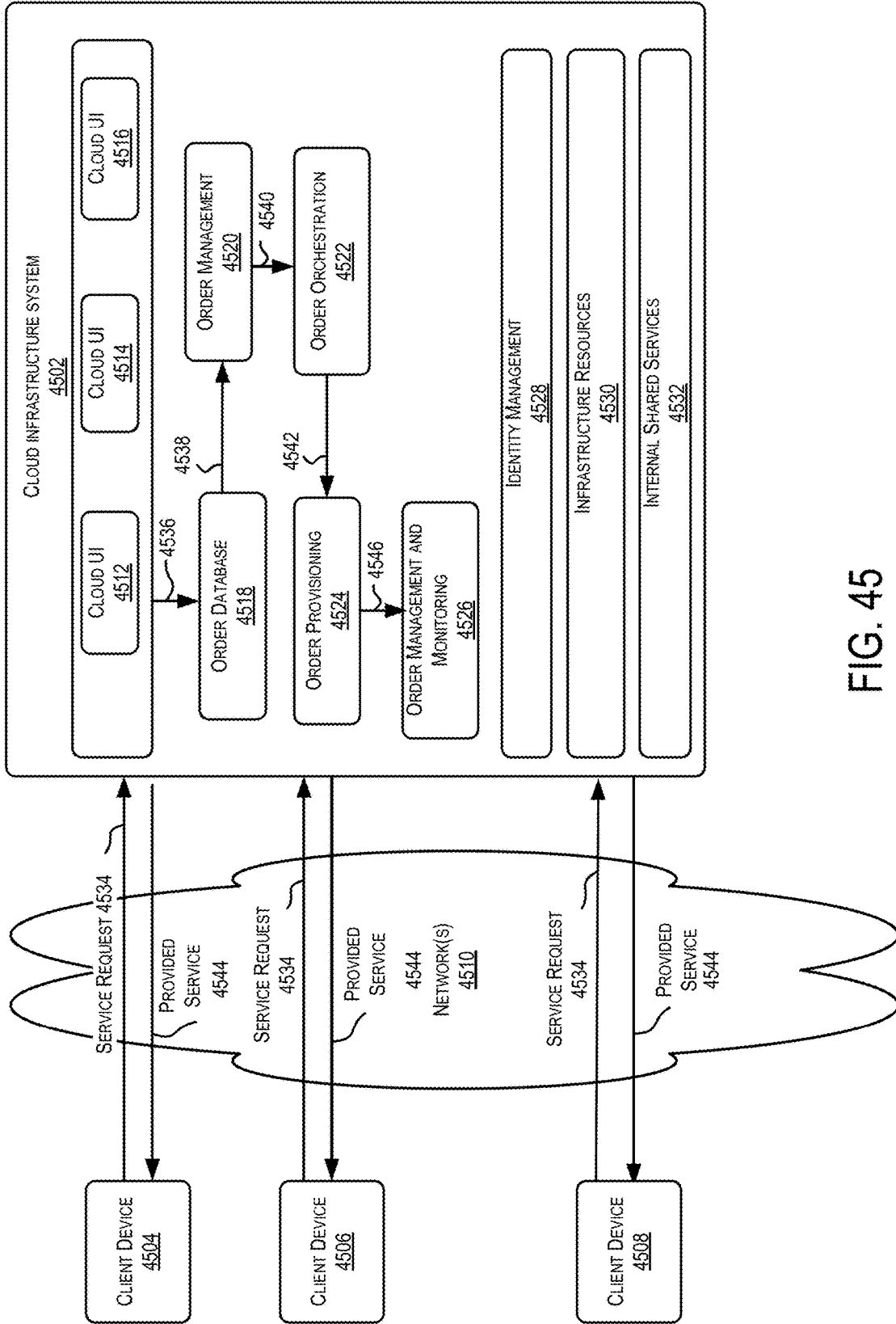

FIG. 45

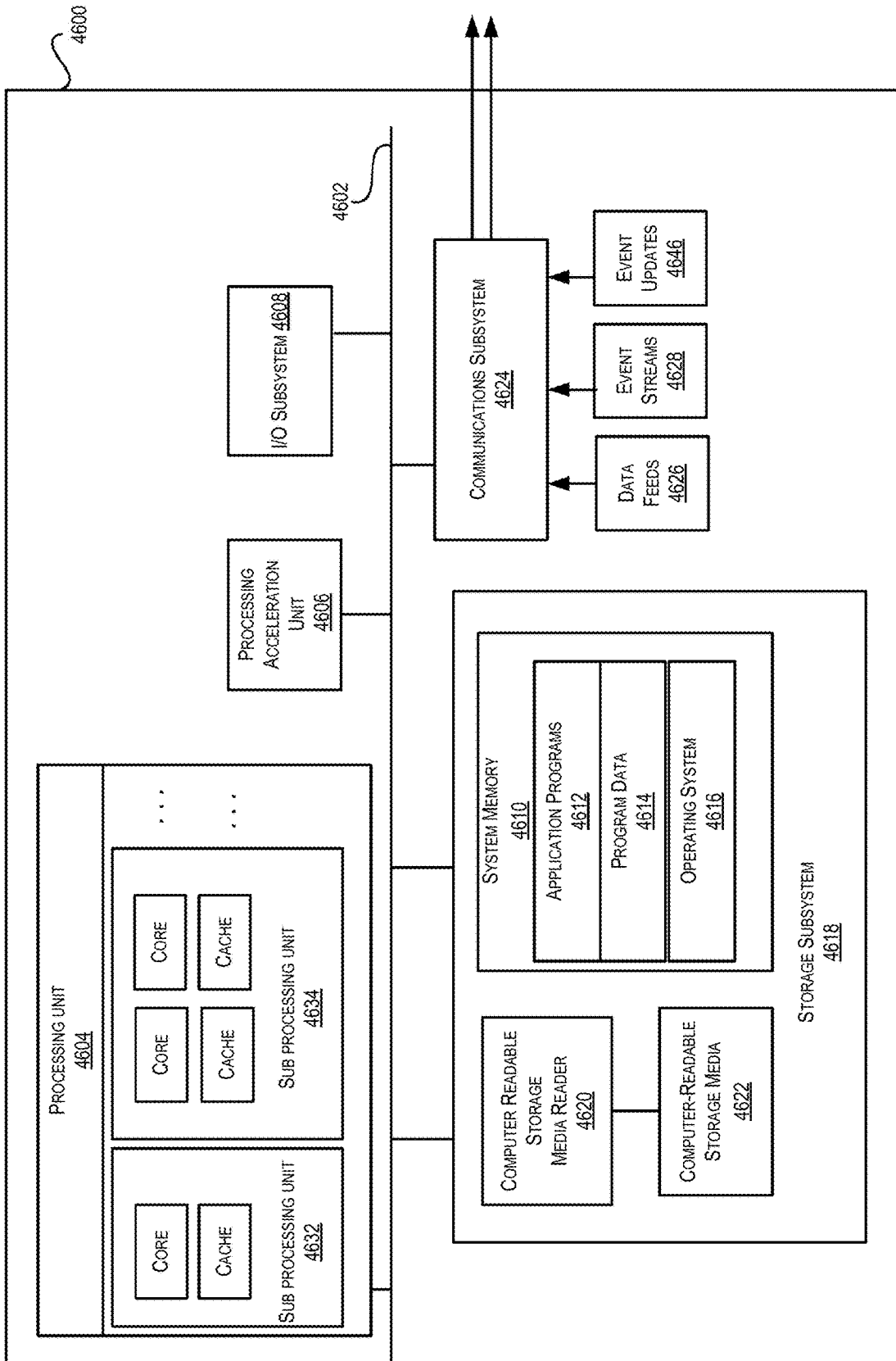

FIG. 46

## ENABLING CHATBOTS BY VALIDATING ARGUMENTATION

### CROSS-REFERENCES TO RELATED APPLICATIONS

**[0001]** This application is a continuation of U.S. Ser. No. 16/260,939, filed Jan. 29, 2019, which is a continuation in part of U.S. Ser. No. 16/010,091, filed Jun. 15, 2018, now U.S. Pat. No. 10,679,011, issued Jun. 9, 2020, which is a continuation in part of U.S. Ser. No. 15/975,683, filed May 9, 2018, all of which are incorporated by reference in their entirety. U.S. Ser. No. 16/260,939, filed Jan. 29, 2019, claims priority from U.S. Ser. No. 62/623,999, filed Jan. 30, 2018, and 62/646,795, filed Mar. 22, 2018, which are incorporated by reference in their entirety.

### TECHNICAL FIELD

**[0002]** This disclosure is generally concerned with linguistics. More specifically, this disclosure relates to using communicative discourse trees to perform discourse analysis.

### STATEMENT AS TO RIGHTS TO INVENTIONS MADE UNDER FEDERALLY SPONSORED RESEARCH AND DEVELOPMENT

**[0003]** Not Applicable

### BACKGROUND

**[0004]** Linguistics is the scientific study of language. One aspect of linguistics is the application of computer science to human natural languages such as English. Due to the greatly increased speed of processors and capacity of memory, computer applications of linguistics are on the rise. For example, computer-enabled analysis of language discourse facilitates numerous applications such as automated agents that can answer questions from users. The use of “chatbots” and agents to answer questions, facilitate discussion, manage dialogues, and provide social promotion is increasingly popular. To address this need, a broad range of technologies including compositional semantics has been developed. Such technologies can support automated agents in the case of simple, short queries and replies.

**[0005]** But such solutions are unable to leverage rich discourse related information to answer questions, perform dialog management, provide recommendations or implement “chatbot” systems, because existing solutions are unable to match an answer with a question due to insufficient rhetorical analysis. For example, existing solutions that use argument mining can extract arguments from text and evaluate an extraction accuracy but cannot perform further analysis of extracted arguments. In another example, existing solutions that use logical artificial intelligence are able to validate simple arguments but cannot validate more complex arguments due to a reliance on an insufficiently robust dataset.

**[0006]** Hence, new solutions are needed.

### BRIEF SUMMARY

**[0007]** Generally, systems, devices, and methods of the present invention are related to communicative discourse trees. For example, an application can determine a presence of argumentation in text and subsequently validate the

argument. More specifically, the application can determine whether the argument is internally and externally consistent, thus whether the argument supports a claim. In so doing, the application enables more accurate and realistic autonomous agents.

**[0008]** In an example, a method determines argumentation in text. The method accesses text that includes fragments. The method creates a discourse tree from a subset of the text. The discourse tree includes nodes, each nonterminal node representing a rhetorical relationship between two of the fragments and each terminal node of the nodes of the discourse tree is associated with one of the fragments. The method forms a communicative discourse tree from the discourse tree by matching each fragment that has a verb to a verb signature. The method identifies that the subset of the text includes an argument corresponding to a claim by applying a classification model trained to detect argumentation to the communicative discourse tree. The method creates a fixed part of a logic system by integrating one or more claim terms and one or more domain definition clauses. The domain definition clauses are associated with a domain of the text. The method creates a variable part of the logic system determining, from the communicative discourse tree, a set of defeasible rules by extracting, from the communicative discourse tree, one or more of (i) an elementary discourse unit that is a rhetorical relation type contrast and (ii) a communicative action that is of a class type disagree and determines a set of facts from one or more of the communicative actions of the communicative discourse tree. The method evaluates a consistency of the argument with respect to itself and with respect to the domain definition clauses by solving the logic system.

**[0009]** In an aspect, the method solves the logic system by determining a defeasible derivation that includes a set of non-contradictory defeasible rules from the defeasible set of rules. The method creates one or more defeater arguments from the set of facts. The method constructs a dialectic tree including a root node representing the argument and leaf nodes that represent the defeater arguments from the defeasible derivation. The method evaluates the dialectic tree by recursively evaluating the defeater arguments. The method, responsive to determining that none of the defeater arguments are contradictory with the defeasible derivation, identifies the argument as valid.

**[0010]** In an aspect, the matching includes accessing verb signatures. Each verb signature includes the verb of the respective fragment and a sequence of thematic roles, wherein thematic roles describe a relationship between the verb and related words. The method determines, for each verb signature of the verb signatures, a thematic role of the signature that matches a role of a word in a respective fragment. The method selects a particular verb signature from the verb signatures based on the particular verb signature comprising a highest number of matches. The method associates the particular verb signature with the fragment.

**[0011]** In an aspect, each verb signature includes an adverb, a noun phrase or a noun. Associating the particular verb signature with the fragment can include identifying each of a thematic roles in the particular verb signature; and matching, for each of the thematic roles in the particular verb signature, a corresponding word in the fragment to the thematic role.



**[0012]** In an aspect, the classification model is a support vector machine with tree kernel learning or the classification model uses nearest neighbor learning of maximal common sub-trees.

**[0013]** In an aspect, applying the classification model to the subset of the text further includes determining similarities between the communicative discourse tree and one or more communicative discourse trees from a training set of communicative discourse trees. The applying further includes selecting an additional communicative discourse tree from the one or more communicative discourse trees based on the additional communicative discourse tree having a highest number of similarities with the communicative discourse tree. The applying further includes identifying whether the additional communicative discourse tree is from a positive set or a negative set, wherein the positive set is associated with text containing argumentation and the negative set is associated with text containing no argumentation. The applying further includes determining, based on the identifying, whether the text contains an argumentation or no argumentation.

**[0014]** In an aspect, accessing the text includes receiving text from a user device. The method can further include adjusting a response based on the validated argumentation and providing the adjusted response to a user device.

**[0015]** The above methods can be implemented as tangible computer-readable media and/or operating within a computer processor and attached memory.

#### BRIEF DESCRIPTION OF THE DRAWINGS

**[0016]** FIG. 1 shows an exemplary rhetoric classification environment in accordance with an aspect.

**[0017]** FIG. 2 depicts an example of a discourse tree in accordance with an aspect.

**[0018]** FIG. 3 depicts a further example of a discourse tree in accordance with an aspect.

**[0019]** FIG. 4 depicts illustrative schemas in accordance with an aspect.

**[0020]** FIG. 5 depicts a node-link representation of the hierarchical binary tree in accordance with an aspect.

**[0021]** FIG. 6 depicts an exemplary indented text encoding of the representation in FIG. 5 in accordance with an aspect.

**[0022]** FIG. 7 depicts an exemplary DT for an example request about property tax in accordance with an aspect.

**[0023]** FIG. 8 depicts an exemplary response for the question represented in FIG. 7.

**[0024]** FIG. 9 illustrates a discourse tree for an official answer in accordance with an aspect.

**[0025]** FIG. 10 illustrates a discourse tree for a raw answer in accordance with an aspect.

**[0026]** FIG. 11 illustrates a communicative discourse tree for a claim of a first agent in accordance with an aspect.

**[0027]** FIG. 12 illustrates a communicative discourse tree for a claim of a second agent in accordance with an aspect.

**[0028]** FIG. 13 illustrates a communicative discourse tree for a claim of a third agent in accordance with an aspect.

**[0029]** FIG. 14 illustrates parse thicketts in accordance with an aspect.

**[0030]** FIG. 15 illustrates an exemplary process for building a communicative discourse tree in accordance with an aspect.

**[0031]** FIG. 16 illustrates a discourse tree and scenario graph in accordance with an aspect.

**[0032]** FIG. 17 illustrates forming a request-response pair in accordance with an aspect.

**[0033]** FIG. 18 illustrates a maximal common sub-communicative discourse tree in accordance with an aspect.

**[0034]** FIG. 19 illustrates a tree in a kernel learning format for a communicative discourse tree in accordance with an aspect.

**[0035]** FIG. 20 illustrates an exemplary process used to implement a rhetoric agreement classifier in accordance with an aspect.

**[0036]** FIG. 21 illustrates a chat bot commenting on a posting in accordance with an aspect.

**[0037]** FIG. 22 illustrates a chat bot commenting on a posting in accordance with an aspect.

**[0038]** FIG. 23 illustrates a discourse tree for algorithm text in accordance with an aspect.

**[0039]** FIG. 24 illustrates annotated sentences in accordance with an aspect.

**[0040]** FIG. 25 illustrates annotated sentences in accordance with an aspect.

**[0041]** FIG. 26 illustrates discourse acts of a dialogue in accordance with an aspect.

**[0042]** FIG. 27 illustrates discourse acts of a dialogue in accordance with an aspect.

**[0043]** FIG. 28 depicts an exemplary communicative discourse tree in accordance with an aspect.

**[0044]** FIG. 29 depicts an exemplary communicative discourse tree in accordance with an aspect.

**[0045]** FIG. 30 depicts an exemplary communicative discourse tree in accordance with an aspect.

**[0046]** FIG. 31 depicts an exemplary communicative discourse tree in accordance with an aspect.

**[0047]** FIG. 32 depicts an example communicative discourse tree in accordance with an aspect.

**[0048]** FIG. 33 depicts an example communicative discourse tree in accordance with an aspect.

**[0049]** FIG. 34 depicts an example communicative discourse tree in accordance with an aspect.

**[0050]** FIG. 35 depicts an example communicative discourse tree in accordance with an aspect.

**[0051]** FIG. 36 depicts an exemplary process for using machine learning to determine argumentation in accordance with an aspect.

**[0052]** FIG. 37 is a fragment of a discourse tree in accordance with an aspect.

**[0053]** FIG. 38 depicts a discourse tree for a borderline review in accordance with an aspect.

**[0054]** FIG. 39 depicts a discourse tree for a sentence showing compositional semantic approach to sentiment analysis in accordance with an aspect.

**[0055]** FIG. 40 depicts an exemplary method for validating arguments in accordance with an aspect.

**[0056]** FIG. 41 depicts an exemplary communicative discourse tree for an argument in accordance with an aspect.

**[0057]** FIG. 42 depicts an exemplary method for validating arguments using defeasible logic programming in accordance with an aspect.

**[0058]** FIG. 43 depicts an exemplary dialectic tree in accordance with an aspect.

**[0059]** FIG. 44 depicts a simplified diagram of a distributed system for implementing one of the aspects.

**[0060]** FIG. 45 is a simplified block diagram of components of a system environment by which services provided

by the components of an aspect system may be offered as cloud services in accordance with an aspect.

[0061] FIG. 46 illustrates an exemplary computer system, in which various aspects of the present invention may be implemented.

#### DETAILED DESCRIPTION

[0062] Aspects disclosed herein provide technical improvements to the area of computer-implemented linguistics. More specifically, aspects of the present disclosure use communicative discourse trees in conjunction with logic systems to determine a validity of a particular argument detected in a body of text. A valid argument is an argument that is logically consistent, for example, for which the text of the argument supports the premise of the argument.

[0063] Technical advantages of some aspects include improved autonomous agents such as chatbots that can validate argumentation in text using Communicative Discourse Trees. “Communicative discourse trees” or “CDTs” include discourse trees that are supplemented with communicative actions. A communicative action is a cooperative action undertaken by individuals based on mutual deliberation and argumentation.

[0064] More specifically, by incorporating labels that identify communicative actions, learning of communicative discourse trees can occur over a richer features set than simply rhetoric relations and syntax of elementary discourse units (EDUs). With such a feature set, additional techniques such as classification can be used to determine a level of rhetoric agreement between questions and answers or request-response pairs, detecting argumentation in text, and validating argumentation in text, thereby enabling improved automated agents. In so doing, computing systems enable autonomous agents that are capable of intelligently answering questions.

[0065] In an example, a rhetoric classification application generates a communicative discourse tree (CDT) from input text and uses machine learning to validate argumentation in a subset of the text. The rhetoric classification application creates a logic program by extracting facts and defeasible rules from the communicative discourse tree and provides the facts and defeasible rules to a logic system such as Defeasible Logic Programming (DeLP). In turn, the logic system accesses fixed rules and domain specific definition clauses and solves the logic program, thereby determining whether the argumentation is valid (e.g., the argument supports the claim), or invalid (e.g. the argument does not support the claim).

[0066] In another example, a rhetoric classification application executing on a computing device receives a question from a user. The rhetoric classification application generates a communicative discourse tree for the question. A communicative discourse tree is a discourse tree that includes communicative actions. The rhetoric classification application accesses a database of potential answers to the question. Using a predictive model, the rhetoric agreement application determines a level of complementarity between the question and each potential answer. Responsive to determining that the level of complementarity is above a threshold, the rhetoric agreement classifier provides the answer to the user, for example, via a display device.

#### Certain Definitions

[0067] As used herein, “rhetorical structure theory” is an area of research and study that provided a theoretical basis upon which the coherence of a discourse could be analyzed.

[0068] As used herein, “discourse tree” or “DT” refers to a structure that represents the rhetorical relations for a sentence of part of a sentence.

[0069] As used herein, a “rhetorical relation,” “rhetorical relationship,” or “coherence relation” or “discourse relation” refers to how two segments of discourse are logically connected to one another. Examples of rhetorical relations include elaboration, contrast, and attribution.

[0070] As used herein, a “sentence fragment,” or “fragment” is a part of a sentence that can be divided from the rest of the sentence. A fragment is an elementary discourse unit. For example, for the sentence “Dutch accident investigators say that evidence points to pro-Russian rebels as being responsible for shooting down the plane,” two fragments are “Dutch accident investigators say that evidence points to pro-Russian rebels” and “as being responsible for shooting down the plane.” A fragment can, but need not, include a verb.

[0071] As used herein, “signature” or “frame” refers to a property of a verb in a fragment. Each signature can include one or more thematic roles. For example, for the fragment “Dutch accident investigators say that evidence points to pro-Russian rebels,” the verb is “say” and the signature of this particular use of the verb “say” could be “agent verb topic” where “investigators” is the agent and “evidence” is the topic.

[0072] As used herein, “thematic role” refers to components of a signature used to describe a role of one or more words. Continuing the previous example, “agent” and “topic” are thematic roles.

[0073] As used herein, “nuclearity” refers to which text segment, fragment, or span, is more central to a writer’s purpose. The nucleus is the more central span, and the satellite is the less central one.

[0074] As used herein, “coherency” refers to the linking together of two rhetorical relations.

[0075] As used herein, “communicative verb” is a verb that indicates communication. For example, the verb “deny” is a communicative verb.

[0076] As used herein, “communicative action” describes an action performed by one or more agents and the subjects of the agents.

[0077] As used herein, “claim” is an assertion of truth of something. For example, a claim could be “I am not responsible for paying rent this month” or “the rent is late.”

[0078] As used herein, an “argument” is a reason or set of reasons set forth to support a claim. An example argument for the above claim is “the necessary repairs were not completed.”

[0079] As used herein, a “argument validity” or “validity” refers to whether an argument that supports a claim is internally and consistent. Internal consistency refers to whether the argument is consistent with itself, e.g., does not contain two contradictory statements. External consistency refers to whether an argument is consistent with known facts and rules.

[0080] As used herein, a “logic system” or “logic program” is a set of instructions, rules, facts, and other information that can represent argumentation of a particular

claim. Solving the logic system results in a determination of whether the argumentation is valid.

[0081] As used herein, a “dialectic tree” is a tree that represents individual arguments. A dialectic tree is solved to determine a truth or falsity of a claim supported by the individual arguments. Evaluating a dialectic tree involves determining validity of the individual arguments.

[0082] FIG. 1 shows an exemplary rhetoric classification environment in accordance with an aspect. FIG. 1 depicts rhetoric classification computing device 101 and argumentation indicator 165. Rhetoric classification computing device 101 includes one or more of rhetoric classification application 102, answer database 105, rhetoric agreement classifier 120, and training data 125. Rhetoric classification application 102 includes one or more of question communicative discourse tree 110, answer communicative discourse tree 110.

[0083] In an example, rhetoric classification application 102 answers a question received via chat. Input text 130 can be a single question or a stream of questions. Rhetoric classification application 102 creates question communicative discourse tree 110 from input text 130 and selects one or more candidate answers. The answers can be obtained from an existing database such as answer database 105. Input text 130 can be generated by any mobile device such as a mobile phone, smart phone, tablet, laptop, smart watch, and the like. A mobile device can communicate via a data network to rhetoric classification computing device 101. In this manner, a mobile device can provide a question, e.g., from a user, to rhetoric classification computing device 101.

[0084] From the candidate answers, rhetoric classification application 102 determines the most suitable answer. Different methods can be used. In an aspect, rhetoric classification application 102 can create a candidate answer communicative discourse tree for each candidate answer and compare question communicative discourse tree 110 with each candidate discourse tree. Rhetoric classification application 102 identifies a best match between question communicative discourse tree and the candidate answer communicative discourse trees. The rhetoric classification application 102 then accesses or queries a database for the text from the best communicative discourse tree. Rhetoric classification application 102 then sends text associated with the second communicative discourse tree to a mobile device.

[0085] In another aspect, rhetoric classification application 102 creates an answer communicative discourse tree 111 for each candidate answer. Rhetoric classification application 102 then, for each candidate answer, creates a question-answer pair that includes the input text 130 and the candidate answer. Rhetoric classification application 102 provides the question-answer pairs to a predictive model such as rhetoric agreement classifier 120. Using a trained rhetoric agreement classifier 120, rhetoric classification application 102 determines whether the question-answer pair is above a threshold level of matching, e.g., indicating whether the answer addresses the question. If not, the rhetoric classification application 102 continues to analyze additional pairs that include the question and a different answer until a suitable answer is found. By using communicative discourse trees, the rhetorical agreement and communicative actions between the question and answer can be accurately modeled.

[0086] In a further aspect, rhetoric classification application 102 uses rhetoric agreement classifier 120 to determine

whether argumentation is present or absent from input text 130. For example, rhetoric classification application 102 accesses input text 130, which reads: “[t]he rent was properly refused . . . . The landlord contacted me, the tenant, and the rent was requested. However, I refused the rent since I demanded repair to be done. I reminded the landlord about necessary repairs, but the landlord issued the three-day notice confirming that the rent was overdue. Regretfully, the property still stayed unrepaired.” Input text 130 thus includes a claim “the rent was properly refused” and an associated argument “The landlord contacted me, the tenant, and the rent was requested. However, I refused the rent since I demanded repair to be done. I reminded the landlord about necessary repairs, but the landlord issued the three-day notice confirming that the rent was overdue. Regretfully, the property still stayed unrepaired.”

[0087] To detect argumentation, rhetoric classification application 102 determines a communicative discourse tree from input text 130 and provides the communicative discourse tree to a trained classifier such as rhetoric agreement classifier 120. Rhetoric classification application 102 receives a prediction of whether argumentation is present from rhetoric agreement classifier 120. Rhetoric classification application 102 provides the prediction as argumentation indicator 165. Rhetoric agreement classifier 120 compares the communicative discourse tree with communicative discourse trees identified in a training set as positive (argumentation) or negative (no argumentation). An exemplary process is discussed with respect to FIG. 36.

[0088] In yet another aspect, rhetoric classification application 102 can validate argumentation present in input text 130. An exemplary process is discussed with respect to FIG. 40. In an example, rhetoric classification application 102 determines a presence of argumentation, for instance, by using rhetoric agreement classifier 120. Rhetoric classification application 102 can then determine whether a detected argument is valid or invalid. Defeasible Logic Programming can be used. An exemplary process is discussed with respect to FIG. 42. Rhetoric classification application 102 can output argumentation indicator 165 can indicate whether argumentation is detected, and if so, whether an argument is valid or invalid.

#### Rhetoric Structure Theory and Discourse Trees

[0089] Linguistics is the scientific study of language. For example, linguistics can include the structure of a sentence (syntax), e.g., subject-verb-object, the meaning of a sentence (semantics), e.g. dog bites man vs. man bites dog, and what speakers do in conversation, i.e., discourse analysis or the analysis of language beyond the sentence.

[0090] The theoretical underpinnings of discourse, Rhetoric Structure Theory (RST), can be attributed to Mann, William and Thompson, Sandra, “Rhetorical structure theory: A Theory of Text organization,” *Text-Interdisciplinary Journal for the Study of Discourse*, 8(3):243-281, 1988. Similar to how the syntax and semantics of programming language theory helped enable modern software compilers, RST helped enable the analysis of discourse. More specifically RST posits structural blocks on at least two levels, a first level such as nuclearity and rhetorical relations, and a second level of structures or schemas. Discourse parsers or other computer software can parse text into a discourse tree.

[0091] Rhetoric Structure Theory models logical organization of text, a structure employed by a writer, relying on

relations between parts of text. RST simulates text coherence by forming a hierarchical, connected structure of texts via discourse trees. Rhetoric relations are split into the classes of coordinate and subordinate; these relations hold across two or more text spans and therefore implement coherence. These text spans are called elementary discourse units (EDUs). Clauses in a sentence and sentences in a text are logically connected by the author. The meaning of a given sentence is related to that of the previous and the following sentences. This logical relation between clauses is called the coherence structure of the text. RST is one of the most popular theories of discourse, being based on a tree-like discourse structure, discourse trees (DTs). The leaves of a DT correspond to EDUs, the contiguous atomic text spans. Adjacent EDUs are connected by coherence relations (e.g., Attribution, Sequence), forming higher-level discourse units. These units are then also subject to this relation linking. EDUs linked by a relation are then differentiated based on their relative importance: nuclei are the core parts of the relation, while satellites are peripheral ones. As discussed, in order to determine accurate request-response pairs, both topic and rhetorical agreement are analyzed. When a speaker answers a question, such as a phrase or a sentence, the speaker's answer should address the topic of this question. In the case of an implicit formulation of a question, via a seed text of a message, an appropriate answer is expected not only maintain a topic, but also match the generalized epistemic state of this seed.

Rhetoric Relations

[0092] As discussed, aspects described herein use communicative discourse trees. Rhetorical relations can be described in different ways. For example, Mann and Thompson describe twenty-three possible relations. C. Mann, William & Thompson, Sandra. (1987) ("Mann and Thompson"). Rhetorical Structure Theory: A Theory of Text Organization. Other numbers of relations are possible.

Relation Name	Nucleus	Satellite
Antithesis	ideas favored by the author	ideas disfavored by the author
Background	text whose understanding is being facilitated	text for facilitating understanding
Circumstance	text expressing the events or ideas occurring in the interpretive context	an interpretive context of situation or time
Concession	situation affirmed by author	situation which is apparently inconsistent but also affirmed by author
Condition	action or situation whose occurrence results from the occurrence of the conditioning situation	conditioning situation
Elaboration Enablement	basic information an action	additional information information intended to aid the reader in performing an action
Evaluation	a situation	an evaluative comment about the situation
Evidence	a claim	information intended to increase the reader's belief in the claim
Interpretation Justify	a situation text	an interpretation of the situation information supporting the writer's right to express the text

-continued

Relation Name	Nucleus	Satellite
Motivation	an action	information intended to increase the reader's desire to perform the action
Non-volitional Cause	a situation	another situation which causes that one, but not by anyone's deliberate action
Non-volitional Result	a situation	another situation which is caused by that one, but not by anyone's deliberate action
Otherwise (anti conditional)	action or situation whose occurrence results from the lack of occurrence of the conditioning situation	conditioning situation
Purpose Restatement	an intended situation a situation	the intent behind the situation a reexpression of the situation
Solutionhood	a situation or method supporting full or partial satisfaction of the need	a question, request, problem, or other expressed need
Summary Volitional Cause	text a situation	a short summary of that text another situation which causes that one, by someone's deliberate action
Volitional Result	a situation	another situation which is caused by that one, by someone's deliberate action

[0093] Some empirical studies postulate that the majority of text is structured using nucleus-satellite relations. See Mann and Thompson. But other relations do not carry a definite selection of a nucleus. Examples of such relations are shown below.

Relation Name	Span	Other Span
Contrast	One alternate	The other alternate
Joint	(unconstrained)	(unconstrained)
List	An item	A next item
Sequence	An item	A next item

[0094] FIG. 2 depicts an example of a discourse tree in accordance with an aspect. FIG. 2 includes discourse tree 200. Discourse tree includes text span 201, text span 202, text span 203, relation 210 and relation 228. The numbers in FIG. 2 correspond to the three text spans. FIG. 3 corresponds to the following example text with three text spans numbered 1, 2, 3:

[0095] 1. Honolulu, Hawaii will be site of the 2017 Conference on Hawaiian History

[0096] 2. It is expected that 200 historians from the U.S. and Asia will attend

[0097] 3. The conference will be concerned with how the Polynesians sailed to Hawaii

[0098] For example, relation 210, or elaboration, describes the relationship between text span 201 and text span 202. Relation 228 depicts the relationship, elaboration, between text span 203 and 204. As depicted, text spans 202 and 203 elaborate further on text span 201. In the above example, given a goal of notifying readers of a conference, text span 1 is the nucleus. Text spans 2 and 3 provide more detail about the conference. In FIG. 2, a horizontal number, e.g., 1-3, 1, 2, 3 covers a span of text (possibly made up of further spans); a vertical line signals the nucleus or nuclei; and a

curve represents a rhetoric relation (elaboration) and the direction of the arrow points from the satellite to the nucleus. If the text span only functions as a satellite and not as a nuclei, then deleting the satellite would still leave a coherent text. If from FIG. 2 one deletes the nucleus, then text spans 2 and 3 are difficult to understand.

[0099] FIG. 3 depicts a further example of a discourse tree in accordance with an aspect. FIG. 3 includes components 301 and 302, text spans 305-307, relation 310 and relation 328. Relation 310 depicts the relationship 310, enablement, between components 306 and 305, and 307, and 305. FIG. 3 refers to the following text spans:

[0100] 1. The new Tech Report abstracts are now in the journal area of the library near the abridged dictionary.

[0101] 2. Please sign your name by any means that you would be interested in seeing.

[0102] 3. Last day for sign-ups is 31 May.

[0103] As can be seen, relation 328 depicts the relationship between entity 307 and 306, which is enablement. FIG. 3 illustrates that while nuclei can be nested, there exists only one most nuclear text span.

#### Constructing a Discourse Tree

[0104] Discourse trees can be generated using different methods. A simple example of a method to construct a DT bottom up is:

[0105] (1) Divide the discourse text into units by:

[0106] (a) Unit size may vary, depending on the goals of the analysis

[0107] (b) Typically, units are clauses

[0108] (2) Examine each unit, and its neighbors. Is there a relation holding between them?

[0109] (3) If yes, then mark that relation.

[0110] (4) If not, the unit might be at the boundary of a higher-level relation. Look at relations holding between larger units (spans).

[0111] (5) Continue until all the units in the text are accounted for.

[0112] Mann and Thompson also describe the second level of building block structures called schemas applications. In RST, rhetoric relations are not mapped directly onto texts; they are fitted onto structures called schema applications, and these in turn are fitted to text. Schema applications are derived from simpler structures called schemas (as shown by FIG. 4). Each schema indicates how a particular unit of text is decomposed into other smaller text units. A rhetorical structure tree or DT is a hierarchical system of schema applications. A schema application links a number of consecutive text spans, and creates a complex text span, which can in turn be linked by a higher-level schema application. RST asserts that the structure of every coherent discourse can be described by a single rhetorical structure tree, whose top schema creates a span encompassing the whole discourse.

[0113] FIG. 4 depicts illustrative schemas in accordance with an aspect. FIG. 4 shows a joint schema is a list of items consisting of nuclei with no satellites. FIG. 4 depicts schemas 401-406. Schema 401 depicts a circumstance relation between text spans 410 and 428. Scheme 402 depicts a sequence relation between text spans 420 and 421 and a sequence relation between text spans 421 and 422. Schema 403 depicts a contrast relation between text spans 430 and 431. Schema 404 depicts a joint relationship between text spans 440 and 441. Schema 405 depicts a motivation rela-

tionship between 450 and 451, and an enablement relationship between 452 and 451. Schema 406 depicts joint relationship between text spans 460 and 462. An example of a joint scheme is shown in FIG. 4 for the three text spans below:

[0114] 1. Skies will be partly sunny in the New York metropolitan area today.

[0115] 2. It will be more humid, with temperatures in the middle 80's.

[0116] 3. Tonight will be mostly cloudy, with the low temperature between 65 and 70.

[0117] While FIGS. 2-4 depict some graphical representations of a discourse tree, other representations are possible.

[0118] FIG. 5 depicts a node-link representation of the hierarchical binary tree in accordance with an aspect. As can be seen from FIG. 5, the leaves of a DT correspond to contiguous non-overlapping text spans called Elementary Discourse Units (EDUs). Adjacent EDUs are connected by relations (e.g., elaboration, attribution . . . ) and form larger discourse units, which are also connected by relations. "Discourse analysis in RST involves two sub-tasks: discourse segmentation is the task of identifying the EDUs, and discourse parsing is the task of linking the discourse units into a labeled tree." See Joty, Shafiq R and Giuseppe Carenini, Raymond T Ng, and Yashar Mehdad. 2013. Combining intra-and multi-sentential rhetorical parsing for document-level discourse analysis. In ACL (1), pages 486-496.

[0119] FIG. 5 depicts text spans that are leaves, or terminal nodes, on the tree, each numbered in the order they appear in the full text, shown in FIG. 6. FIG. 5 includes tree 500. Tree 500 includes, for example, nodes 501-507. The nodes indicate relationships. Nodes are non-terminal, such as node 501, or terminal, such as nodes 502-507. As can be seen, nodes 503 and 504 are related by a joint relationship. Nodes 502, 505, 506, and 508 are nuclei. The dotted lines indicate that the branch or text span is a satellite. The relations are nodes in gray boxes.

[0120] FIG. 6 depicts an exemplary indented text encoding of the representation in FIG. 5 in accordance with an aspect. FIG. 6 includes text 600 and text sequences 602-604. Text 600 is presented in a manner more amenable to computer programming. Text sequence 602 corresponds to node 502, sequence 603 corresponds to node 503, and sequence 604 corresponds to node 504. In FIG. 6, "N" indicates a nucleus and "S" indicates a satellite.

#### Examples of Discourse Parsers

[0121] Automatic discourse segmentation can be performed with different methods. For example, given a sentence, a segmentation model identifies the boundaries of the composite elementary discourse units by predicting whether a boundary should be inserted before each particular token in the sentence. For example, one framework considers each token in the sentence sequentially and independently. In this framework, the segmentation model scans the sentence token by token, and uses a binary classifier, such as a support vector machine or logistic regression, to predict whether it is appropriate to insert a boundary before the token being examined. In another example, the task is a sequential labeling problem. Once text is segmented into elementary discourse units, sentence-level discourse parsing can be performed to construct the discourse tree. Machine learning techniques can be used.

**[0122]** In one aspect of the present invention, two Rhetorical Structure Theory (RST) discourse parsers are used: CoreNLProcessor which relies on constituent syntax, and FastNLProcessor which uses dependency syntax. See Surdeanu, Mihai & Hicks, Thomas & Antonio Valenzuela-Escarcega, Marco. Two Practical Rhetorical Structure Theory Parsers. (2015).

**[0123]** In addition, the above two discourse parsers, i.e., CoreNLProcessor and FastNLProcessor use Natural Language Processing (NLP) for syntactic parsing. For example, the Stanford CoreNLP gives the base forms of words, their parts of speech, whether they are names of companies, people, etc., normalize dates, times, and numeric quantities, mark up the structure of sentences in terms of phrases and syntactic dependencies, indicate which noun phrases refer to the same entities. Practically, RST is a still theory that may work in many cases of discourse, but in some cases, it may not work. There are many variables including, but not limited to, what EDUs are in a coherent text, i.e., what discourse segmenters are used, what relations inventory is used and what relations are selected for the EDUs, the corpus of documents used for training and testing, and even what parsers are used. So for example, in Surdeanu, et al., “Two Practical Rhetorical Structure Theory Parsers,” paper cited above, tests must be run on a particular corpus using specialized metrics to determine which parser gives better performance. Thus unlike computer language parsers which give predictable results, discourse parsers (and segmenters) can give unpredictable results depending on the training and/or test text corpus. Thus, discourse trees are a mixture of the predicable arts (e.g., compilers) and the unpredictable arts (e.g., like chemistry were experimentation is needed to determine what combinations will give you the desired results).

**[0124]** In order to objectively determine how good a Discourse analysis is, a series of metrics are being used, e.g., Precision/Recall/F1 metrics from Daniel Marcu, “The Theory and Practice of Discourse Parsing and Summarization,” MIT Press, (2000). Precision, or positive predictive value is the fraction of relevant instances among the retrieved instances, while recall (also known as sensitivity) is the fraction of relevant instances that have been retrieved over the total amount of relevant instances. Both precision and recall are therefore based on an understanding and measure of relevance. Suppose a computer program for recognizing dogs in photographs identifies eight dogs in a picture containing 12 dogs and some cats. Of the eight dogs identified, five actually are dogs (true positives), while the rest are cats (false positives). The program’s precision is 5/8 while its recall is 5/12. When a search engine returns 30 pages only 20 of which were relevant while failing to return 40 additional relevant pages, its precision is 20/30=2/3 while its recall is 20/60=1/3. Therefore, in this case, precision is ‘how useful the search results are’, and recall is ‘how complete the results are.’” The F1 score (also F-score or F-measure) is a measure of a test’s accuracy. It considers both the precision and the recall of the test to compute the score:  $F1=2 \times ((\text{precision} \times \text{recall}) / (\text{precision} + \text{recall}))$  and is the harmonic mean of precision and recall. The F1 score reaches its best value at 1 (perfect precision and recall) and worst at 0.

Autonomous Agents or Chatbots

**[0125]** A conversation between Human A and Human B is a form of discourse. For example, applications exist such as FaceBook® Messenger, WhatsApp®, Slack®, SMS, etc., a conversation between A and B may typically be via messages in addition to more traditional email and voice conversations. A chatbot (which may also be called intelligent bots or virtual assistant, etc.) is an “intelligent” machine that, for example, replaces human B and to various degrees mimics the conversation between two humans. An example ultimate goal is that human A cannot tell whether B is a human or a machine (the Turing test, developed by Alan Turing in 1950). Discourse analysis, artificial intelligence, including machine learning, and natural language processing, have made great strides toward the long-term goal of passing the Turing test. Of course, with computers being more and more capable of searching and processing vast repositories of data and performing complex analysis on the data to include predictive analysis, the long-term goal is the chatbot being human-like and a computer combined.

**[0126]** For example, users can interact with the Intelligent Bots Platform through a conversational interaction. This interaction, also called the conversational user interface (UI), is a dialog between the end user and the chatbot, just as between two human beings. It could be as simple as the end user saying “Hello” to the chatbot and the chatbot responding with a “Hi” and asking the user how it can help, or it could be a transactional interaction in a banking chatbot, such as transferring money from one account to the other, or an informational interaction in a HR chatbot, such as checking for vacation balance, or asking an FAQ in a retail chatbot, such as how to handle returns. Natural language processing (NLP) and machine learning (ML) algorithms combined with other approaches can be used to classify end user intent. An intent at a high level is what the end user would like to accomplish (e.g., get account balance, make a purchase). An intent is essentially, a mapping of customer input to a unit of work that the backend should perform. Therefore, based on the phrases uttered by the user in the chatbot, these are mapped that to a specific and discrete use case or unit of work, for e.g. check balance, transfer money and track spending are all “use cases” that the chatbot should support and be able to work out which unit of work should be triggered from the free text entry that the end user types in a natural language.

**[0127]** The underlying rationale for having an AI chatbot respond like a human is that the human brain can formulate and understand the request and then give a good response to the human request much better than a machine. Thus, there should be significant improvement in the request/response of a chatbot, if human B is mimicked. So an initial part of the problem is how does the human brain formulate and understand the request? To mimic, a model is used. RST and DT allow a formal and repeatable way of doing this.

**[0128]** At a high level, there are typically two types of requests: (1) A request to perform some action; and (2) a request for information, e.g., a question. The first type has a response in which a unit of work is created. The second type has a response that is, e.g., a good answer, to the question. The answer could take the form of, for example, in some aspects, the AI constructing an answer from its extensive knowledge base(s) or from matching the best existing answer from searching the internet or intranet or other public/private available data sources.

## Communicative Discourse Trees and The Rhetoric Classifier

[0129] Aspects of the present disclosure build communicative discourse trees and use communicative discourse trees to analyze whether the rhetorical structure of a request or question agrees with an answer. More specifically, aspects described herein create representations of a request-response pair, learns the representations, and relates the pairs into classes of valid or invalid pairs. In this manner, an autonomous agent can receive a question from a user, process the question, for example, by searching for multiple answers, determine the best answer from the answers, and provide the answer to the user.

[0130] More specifically, to represent linguistic features of text, aspects described herein use rhetoric relations and speech acts (or communicative actions). Rhetoric relations are relationships between the parts of the sentences, typically obtained from a discourse tree. Speech acts are obtained as verbs from a verb resource such as VerbNet. By using both rhetoric relations and communicative actions, aspects described herein can correctly recognize valid request-response pairs. To do so, aspects correlate the syntactic structure of a question with that of an answer. By using the structure, a better answer can be determined.

[0131] For example, when an autonomous agent receives an indication from a person that the person desires to sell an item with certain features, the autonomous agent should provide a search result that not only contains the features but also indicates an intent to buy. In this manner, the autonomous agent has determined the user's intent. Similarly, when an autonomous agent receives a request from a person to share knowledge about a particular item, the search result should contain an intent to receive a recommendation. When a person asks an autonomous agent for an opinion about a subject, the autonomous agent shares an opinion about the subject, rather than soliciting another opinion.

## Analyzing Request and Response Pairs

[0132] FIG. 7 depicts an exemplary DT for an example request about property tax in accordance with an aspect. The node labels are the relations and the arrowed line points to the satellite. The nucleus is a solid line. FIG. 7 depicts the following text.

[0133] Request: "My husbands' grandmother gave him his grandfather's truck. She signed the title over but due to my husband having unpaid fines on his license, he was not able to get the truck put in his name. I wanted to put in my name and paid the property tax and got insurance for the truck. By the time it came to sending off the title and getting the tag, I didn't have the money to do so. Now, due to circumstances, I am not going to be able to afford the truck. I went to the insurance place and was refused a refund. I am just wondering that since I am not going to have a tag on this truck, is it possible to get the property tax refunded?"

[0134] Response: "The property tax is assessed on property that you own. Just because you chose to not register it does not mean that you don't own it, so the tax is not refundable. Even if you have not titled the vehicle yet, you still own it within the boundaries of the tax district, so the tax is payable. Note that all states give you a limited amount of time to transfer title and pay the use tax. If you apply late, there will be penalties on top of the normal taxes and fees.

You don't need to register it at the same time, but you absolutely need to title it within the period of time stipulated in state law."

[0135] As can be seen in FIG. 7, analyzing the above text results in the following. "My husbands' grandmother gave him his grandfather's truck" is elaborated by "She signed the title over but due to my husband" elaborated by "having unpaid fines on his license, he was not able to get the truck put in his name." which is elaborated by "I wanted to put in my name," "and paid the property tax", and "and got insurance for the truck."

[0136] "My husbands' grandmother gave him his grandfather's truck. She signed the title over but due to my husband having unpaid fines on his license, he was not able to get the truck put in his name. I wanted to put in my name and paid the property tax and got insurance for the truck." is elaborated by;

[0137] "I didn't have the money" elaborated by "to do so" contrasted with

[0138] "By the time" elaborated by "it came to sending off the title"

[0139] "and getting the tag"

[0140] "My husbands' grandmother gave him his grandfather's truck. She signed the title over but due to my husband having unpaid fines on his license, he was not able to get the truck put in his name. I wanted to put in my name and paid the property tax and got insurance for the truck. By the time it came to sending off the title and getting the tag, I didn't have the money to do so" is contrasted with

[0141] "Now, due to circumstances," elaborated with "I am not going to be able to afford the truck." which is elaborated with

[0142] "I went to the insurance place"

[0143] "and was refused a refund"

[0144] "My husbands' grandmother gave him his grandfather's truck. She signed the title over but due to my husband having unpaid fines on his license, he was not able to get the truck put in his name. I wanted to put in my name and paid the property tax and got insurance for the truck. By the time it came to sending off the title and getting the tag, I didn't have the money to do so. Now, due to circumstances, I am not going to be able to afford the truck. I went to the insurance place and was refused a refund." is elaborated with

[0145] "I am just wondering that since I am not going to have a tag on this truck, is it possible to get the property tax refunded?"

[0146] "I am just wondering" has attribution to

[0147] "that" is the same unit as "is it possible to get the property tax refunded?" which has condition "since I am not going to have a tag on this truck"

[0148] As can be seen, the main subject of the topic is "Property tax on a car". The question includes the contradiction: on one hand, all properties are taxable, and on the other hand, the ownership is somewhat incomplete. A good response has to address both topic of the question and clarify the inconsistency. To do that, the responder is making even stronger claim concerning the necessity to pay tax on whatever is owned irrespectively of the registration status. This example is a member of positive training set from our Yahoo! Answers evaluation domain. The main subject of the topic is "Property tax on a car". The question includes the contradiction: on one hand, all properties are taxable, and on the other hand, the ownership is somewhat incomplete. A

good answer/response has to address both topic of the question and clarify the inconsistency. The reader can observe that since the question includes rhetoric relation of contrast, the answer has to match it with a similar relation to be convincing. Otherwise, this answer would look incomplete even to those who are not domain experts.

**[0149]** FIG. 8 depicts an exemplary response for the question represented in FIG. 7, according to certain aspects of the present invention. The central nucleus is “the property tax is assessed on property” elaborated by “that you own”. “The property tax is assessed on property that you own” is also a nucleus elaborated by “Just because you chose to not register it does not mean that you don’t own it, so the tax is not refundable. Even if you have not titled the vehicle yet, you still own it within the boundaries of the tax district, so the tax is payable. Note that all states give you a limited amount of time to transfer title and pay the use tax.”

**[0150]** The nucleus “The property tax is assessed on property that you own. Just because you chose to not register it does not mean that you don’t own it, so the tax is not refundable. Even if you have not titled the vehicle yet, you still own it within the boundaries of the tax district, so the tax is payable. Note that all states give you a limited amount of time to transfer title and pay the use tax.” is elaborated by “there will be penalties on top of the normal taxes and fees” with condition “If you apply late,” which in turn is elaborated by the contrast of “but you absolutely need to title it within the period of time stipulated in state law.” and “You don’t need to register it at the same time.”

**[0151]** Comparing the DT of FIG. 7 and DT of FIG. 8, enables a determination of how well matched the response (FIG. 8) is to the request (FIG. 7). In some aspects of the present invention, the above framework is used, at least in part, to determine the DTs for the request/response and the rhetoric agreement between the DTs.

**[0152]** In another example, the question “What does The Investigative Committee of the Russian Federation do” has at least two answers, for example, an official answer or an actual answer.

**[0153]** FIG. 9 illustrates a discourse tree for an official answer in accordance with an aspect. As depicted in FIG. 9, an official answer, or mission statement states that “The Investigative Committee of the Russian Federation is the main federal investigating authority which operates as Russia’s Anti-corruption agency and has statutory responsibility for inspecting the police forces, combating police corruption and police misconduct, is responsible for conducting investigations into local authorities and federal governmental bodies.”

**[0154]** FIG. 10 illustrates a discourse tree for a raw answer in accordance with an aspect. As depicted in FIG. 10, another, perhaps more honest, answer states that “Investigative Committee of the Russian Federation is supposed to fight corruption. However, top-rank officers of the Investigative Committee of the Russian Federation are charged with creation of a criminal community. Not only that, but their involvement in large bribes, money laundering, obstruction of justice, abuse of power, extortion, and racketeering has been reported. Due to the activities of these officers, dozens of high-profile cases including the ones against criminal lords had been ultimately ruined.”

**[0155]** The choice of answers depends on context. Rhetoric structure allows differentiating between “official”, “politically correct”, template-based answers and “actual”,

“raw”, “reports from the field”, or “controversial” answers, see FIGS. 9 and 10). Sometimes, the question itself can give a hint about which category of answers is expected. If a question is formulated as a factoid or definitional one, without a second meaning, then the first category of answers is suitable. Otherwise, if a question has the meaning “tell me what it really is”, then the second category is appropriate. In general, after extracting a rhetoric structure from a question, selecting a suitable answer that would have a similar, matching, or complementary rhetoric structure is easier.

**[0156]** The official answer is based on elaboration and joints, which are neutral in terms of controversy a text might contain (See FIG. 9). At the same time, the raw answer includes the contrast relation. This relation is extracted between the phrase for what an agent is expected to do and what this agent was discovered to have done.

#### Classification of Request-Response Pairs

**[0157]** Rhetoric classification application 102 can determine whether a given answer or response, such as an answer obtained from answer database 105 or a public database, is responsive to a given question, or request. More specifically, rhetoric classification application 102 analyzes whether a request and response pair is correct or incorrect by determining one or both of (i) relevance or (ii) rhetoric agreement between the request and the response. Rhetoric agreement can be analyzed without taking into account relevance, which can be treated orthogonally.

**[0158]** Rhetoric classification application 102 can determine similarity between question-answer pairs using different methods. For example, rhetoric classification application 102 can determine level of similarity between an individual question and an individual answer. Alternatively, rhetoric classification application 102 can determine a measure of similarity between a first pair including a question and an answer, and a second pair including a question and answer.

**[0159]** For example, rhetoric classification application 102 uses rhetoric agreement classifier 120 trained to predict matching or non-matching answers. Rhetoric classification application 102 can process two pairs at a time, for example  $\langle q1, a1 \rangle$  and  $\langle q2, a2 \rangle$ . Rhetoric classification application 102 compares  $q1$  with  $q2$  and  $a1$  with  $a2$ , producing a combined similarity score. Such a comparison allows a determination of whether an unknown question/answer pair contains a correct answer or not by assessing a distance from another question/answer pair with a known label. In particular, an unlabeled pair  $\langle q2, a2 \rangle$  can be processed so that rather than “guessing” correctness based on words or structures shared by  $q2$  and  $a2$ , both  $q2$  and  $a2$  can be compared with their corresponding components  $q1$  and  $a2$  of the labeled pair  $\langle q2, a2 \rangle$  on the grounds of such words or structures. Because this approach targets a domain-independent classification of an answer, only the structural cohesiveness between a question and answer can be leveraged, not ‘meanings’ of answers.

**[0160]** In an aspect, rhetoric classification application 102 uses training data 125 to train rhetoric agreement classifier 120. In this manner, rhetoric agreement classifier 120 is trained to determine a similarity between pairs of questions and answers. This is a classification problem. Training data 125 can include a positive training set and a negative training set. Training data 125 includes matching request-response pairs in a positive dataset and arbitrary or lower relevance or appropriateness request-response pairs in a



negative dataset. For the positive dataset, various domains with distinct acceptance criteria are selected that indicate whether an answer or response is suitable for the question.

**[0161]** Each training data set includes a set of training pairs. Each training set includes a question communicative discourse tree that represents a question and an answer communicative discourse tree that represents an answer and an expected level of complementarity between the question and answer. By using an iterative process, rhetoric classification application **102** provides a training pair to rhetoric agreement classifier **120** and receives, from the model, a level of complementarity. Rhetoric classification application **102** calculates a loss function by determining a difference between the determined level of complementarity and an expected level of complementarity for the particular training pair. Based on the loss function, rhetoric classification application **102** adjusts internal parameters of the classification model to minimize the loss function.

**[0162]** Acceptance criteria can vary by application. For example, acceptance criteria may be low for community question answering, automated question answering, automated and manual customer support systems, social network communications and writing by individuals such as consumers about their experience with products, such as reviews and complaints. RR acceptance criteria may be high in scientific texts, professional journalism, health and legal documents in the form of FAQ, professional social networks such as “stackoverflow.”

#### Communicative Discourse Trees (CDTs)

**[0163]** Rhetoric classification application **102** can create, analyze, and compare communicative discourse trees. Communicative discourse trees are designed to combine rhetoric information with speech act structures. CDTs include with arcs labeled with expressions for communicative actions. By combining communicative actions, CDTs enable the modeling of RST relations and communicative actions. A CDT is a reduction of a parse thicket. See Galitsky, B, Ilvovsky, D. and Kuznetsov S O. Rhetoric Map of an Answer to Compound Queries Knowledge Trail Inc. ACL 2015, 681-686. (“Galitsky 2015”). A parse thicket is a combination of parse trees for sentences with discourse-level relationships between words and parts of the sentence in one graph. By incorporating labels that identify speech actions, learning of communicative discourse trees can occur over a richer features set than just rhetoric relations and syntax of elementary discourse units (EDUs).

**[0164]** In an example, a dispute between three parties concerning the causes of a downing of a commercial airliner, Malaysia Airlines Flight 17 is analyzed. An RST representation of the arguments being communicated is built. In the example, three conflicting agents, Dutch investigators, The Investigative Committee of the Russian Federation, and the self-proclaimed Donetsk People’s Republic exchange their opinions on the matter. The example illustrates a controversial conflict where each party does all it can to blame its opponent. To sound more convincing, each party does not just produce its claim but formulates a response in a way to rebuff the claims of an opponent. To achieve this goal, each party attempts to match the style and discourse of the opponents’ claims.

**[0165]** FIG. **11** illustrates a communicative discourse tree for a claim of a first agent in accordance with an aspect. FIG. **11** depicts communicative discourse tree **100**, which repre-

sents the following text: “Dutch accident investigators say that evidence points to pro-Russian rebels as being responsible for shooting down plane. The report indicates where the missile was fired from and identifies who was in control of the territory and pins the downing of MH17 on the pro-Russian rebels.”

**[0166]** As can be seen from FIG. **11**, non-terminal nodes of CDTs are rhetoric relations, and terminal nodes are elementary discourse units (phrases, sentence fragments) which are the subjects of these relations. Certain arcs of CDTs are labeled with the expressions for communicative actions, including the actor agent and the subject of these actions (what is being communicated). For example, the nucleus node for elaboration relation (on the left) are labeled with say (Dutch, evidence), and the satellite with responsible (rebels, shooting down). These labels are not intended to express that the subjects of EDUs are evidence and shooting down but instead for matching this CDT with others for the purpose of finding similarity between them. In this case just linking these communicative actions by a rhetoric relation and not providing information of communicative discourse would be too limited way to represent a structure of what and how is being communicated. A requirement for an RR pair to have the same or coordinated rhetoric relation is too weak, so an agreement of CDT labels for arcs on top of matching nodes is required.

**[0167]** The straight edges of this graph are syntactic relations, and curvy arcs are discourse relations, such as anaphora, same entity, sub-entity, rhetoric relation and communicative actions. This graph includes much richer information than just a combination of parse trees for individual sentences. In addition to CDTs, parse thickets can be generalized at the level of words, relations, phrases and sentences. The speech actions are logic predicates expressing the agents involved in the respective speech acts and their subjects. The arguments of logical predicates are formed in accordance to respective semantic roles, as proposed by a framework such as VerbNet. See Karin Kipper, Anna Korhonen, Neville Ryant, Martha Palmer, A Large-scale Classification of English Verbs, Language Resources and Evaluation Journal, 42(1), pp. 21-40, Springer Netherland, 2008. and/or Karin Kipper Schuler, Anna Korhonen, Susan W. Brown, VerbNet overview, extensions, mappings and apps, Tutorial, NAACL-HLT 2009, Boulder, Colorado.

**[0168]** FIG. **12** illustrates a communicative discourse tree for a claim of a second agent in accordance with an aspect. FIG. **12** depicts communicative discourse tree **1200**, which represents the following text: “The Investigative Committee of the Russian Federation believes that the plane was hit by a missile, which was not produced in Russia. The committee cites an investigation that established the type of the missile.”

**[0169]** FIG. **13** illustrates a communicative discourse tree for a claim of a third agent in accordance with an aspect. FIG. **13** depicts communicative discourse tree **1300**, which represents the following text: “Rebels, the self-proclaimed Donetsk People’s Republic, deny that they controlled the territory from which the missile was allegedly fired. It became possible only after three months after the tragedy to say if rebels controlled one or another town.”

**[0170]** As can be seen from communicative discourse trees **1100-1300**, a response is not arbitrary. A response talks about the same entities as the original text. For example, communicative discourse trees **1200** and **1300** are related to

communicative discourse tree **1100**. A response backs up a disagreement with estimates and sentiments about these entities, and about actions of these entities.

**[0171]** More specifically, replies of involved agent need to reflect the communicative discourse of the first, seed message. As a simple observation, because the first agent uses Attribution to communicate his claims, the other agents have to follow the suite and either provide their own attributions or attack the validity of attribution of the proponent, or both. To capture a broad variety of features for how communicative structure of the seed message needs to be retained in consecutive messages, pairs of respective CDTs can be learned.

**[0172]** To verify the agreement of a request-response, discourse relations or speech acts (communicative actions) alone are often insufficient. As can be seen from the example depicted in FIGS. **11-13**, the discourse structure of interactions between agents and the kind of interactions are useful. However, the domain of interaction (e.g., military conflicts or politics) or the subjects of these interactions, i.e., the entities, do not need to be analyzed.

#### Representing Rhetoric Relations and Communicative Actions

**[0173]** In order to compute similarity between abstract structures, two approaches are frequently used: (1) representing these structures in a numerical space, and express similarity as a number, which is a statistical learning approach, or (2) using a structural representation, without numerical space, such as trees and graphs, and expressing similarity as a maximal common sub-structure. Expressing similarity as a maximal common sub-structure is referred to as generalization.

**[0174]** Learning communicative actions helps express and understand arguments. Computational verb lexicons help support acquisition of entities for actions and provide a rule-based form to express their meanings. Verbs express the semantics of an event being described as well as the relational information among participants in that event, and project the syntactic structures that encode that information. Verbs, and in particular communicative action verbs, can be highly variable and can display a rich range of semantic behaviors. In response, verb classification helps a learning systems to deal with this complexity by organizing verbs into groups that share core semantic properties.

**[0175]** VerbNet is one such lexicon, which identifies semantic roles and syntactic patterns characteristic of the verbs in each class and makes explicit the connections between the syntactic patterns and the underlying semantic relations that can be inferred for all members of the class. See Karin Kipper, Anna Korhonen, Neville Ryant and Martha Palmer, *Language Resources and Evaluation*, Vol. 42, No. 1 (March 2008), at 21. Each syntactic frame, or verb signature, for a class has a corresponding semantic representation that details the semantic relations between event participants across the course of the event.

**[0176]** For example, the verb amuse is part of a cluster of similar verbs that have a similar structure of arguments (semantic roles) such as amaze, anger, arouse, disturb, and irritate. The roles of the arguments of these communicative actions are as follows: Experiencer (usually, an animate entity), Stimulus, and Result. Each verb can have classes of meanings differentiated by syntactic features for how this verb occurs in a sentence, or frames. For example, the

frames for amuse are as follows, using the following key noun phrase (NP), noun (N), communicative action (V), verb phrase (VP), adverb (ADV):

**[0177]** NP V NP. Example: “The teacher amused the children.” Syntax: Stimulus V Experiencer. Clause: amuse (Stimulus, E, Emotion, Experiencer), cause(Stimulus, E), emotional\_state(result(E), Emotion, Experiencer).

**[0178]** NP V ADV-Middle. Example: “Small children amuse quickly.” Syntax: Experiencer V ADV. Clause: amuse (Experiencer, Prop):-, property(Experiencer, Prop), adv (Prop). NP V NP-PRO-ARB. Example “The teacher amused.” Syntax Stimulus V. amuse(Stimulus, E, Emotion, Experiencer):. cause(Stimulus, E), emotional\_state(result(E), Emotion, Experiencer).

**[0179]** NP.cause V NP. Example “The teacher’s dolls amused the children.” syntax Stimulus <+genitive> (’s) V Experiencer. amuse(Stimulus, E, Emotion, Experiencer):. cause(Stimulus, E), emotional\_state(during(E), Emotion, Experiencer).

**[0180]** NP V NP ADJ. Example “This performance bored me totally.” syntax Stimulus V Experiencer Result. amuse (Stimulus, E, Emotion, Experiencer). cause(Stimulus, E),emotional\_state(result(E), Emotion, Experiencer), Pred (result(E), Experiencer).

**[0181]** Communicative actions can be characterized into clusters, for example: Verbs with Predicative Complements (Appoint, characterize, dub, declare, conjecture, masquerade, orphan, captain, consider, classify), Verbs of Perception (See, sight, peer). Verbs of Psychological State (Amuse, admire, marvel, appeal), Verbs of Desire (Want, long). Judgment Verbs (Judgment), Verbs of Assessment (Assess, estimate), Verbs of Searching (Hunt, search, stalk, investigate, rummage, ferret), Verbs of Social Interaction (Correspond, marry, meet, battle), Verbs of Communication (Transfer(message), inquire, interrogate, tell, manner(speaking), talk, chat, say, complain, advise, confess, lecture, overstate, promise). Avoid Verbs (Avoid), Measure Verbs, (Register, cost, fit, price, bill), Aspectual Verbs (Begin, complete, continue, stop, establish, sustain).

**[0182]** Aspects described herein provide advantages over statistical learning models. In contrast to statistical solutions, aspects use a classification system can provide a verb or a verb-like structure which is determined to cause the target feature (such as rhetoric agreement). For example, statistical machine learning models express similarity as a number, which can make interpretation difficult.

#### Representing Request-Response Pairs

**[0183]** Representing request-response pairs facilitates classification based operations based on a pair. In an example, request-response pairs can be represented as parse thickets. A parse thicket is a representation of parse trees for two or more sentences with discourse-level relationships between words and parts of the sentence in one graph. See Galitsky 2015. Topical similarity between question and answer can expressed as common sub-graphs of parse thickets. The higher the number of common graph nodes, the higher the similarity.

**[0184]** FIG. **14** illustrates parse thickets in accordance with an aspect. FIG. **14** depicts parse thicket **1400** including a parse tree for a request **1401**, and a parse tree for a corresponding response **1402**.

**[0185]** Parse tree **1401** represents the question “I just had a baby and it looks more like the husband I had my baby

with. However it does not look like me at all and I am scared that he was cheating on me with another lady and I had her kid. This child is the best thing that has ever happened to me and I cannot imagine giving my baby to the real mom.”

[0186] Response 1402 represents the response “Marital therapists advise on dealing with a child being born from an affair as follows. One option is for the husband to avoid contact but just have the basic legal and financial commitments. Another option is to have the wife fully involved and have the baby fully integrated into the family just like a child from a previous marriage.”

[0187] FIG. 14 represents a greedy approach to representing linguistic information about a paragraph of text. The straight edges of this graph are syntactic relations, and curvy arcs are discourse relations, such as anaphora, same entity, sub-entity, rhetoric relation and communicative actions. The solid arcs are for same entity/sub-entity/anaphora relations, and the dotted arcs are for rhetoric relations and communicative actions. Oval labels in straight edges denote the syntactic relations. Lemmas are written in the boxes for the nodes, and lemma forms are written on the right side of the nodes.

[0188] Parse thicket 1400 includes much richer information than just a combination of parse trees for individual sentences. Navigation through this graph along the edges for syntactic relations as well as arcs for discourse relations allows to transform a given parse thicket into semantically equivalent forms for matching with other parse thickets, performing a text similarity assessment task. To form a complete formal representation of a paragraph, as many links as possible are expressed. Each of the discourse arcs produces a pair of thicket phrases that can be a potential match.

[0189] Topical similarity between the seed (request) and response is expressed as common sub-graphs of parse thickets. They are visualized as connected clouds. The higher the number of common graph nodes, the higher the similarity. For rhetoric agreement, common sub-graph does not have to be large as it is in the given text. However, rhetoric relations and communicative actions of the seed and response are correlated and a correspondence is required.

#### Generalization for Communicative Actions

[0190] A similarity between two communicative actions  $A_1$  and  $A_2$  is defined as an abstract verb which possesses the features which are common between  $A_1$  and  $A_2$ . Defining a similarity of two verbs as an abstract verb-like structure supports inductive learning tasks, such as a rhetoric agreement assessment. In an example, a similarity between the following two common verbs, agree and disagree, can be generalized as follows:  $\text{agree} \hat{=} \text{disagree} = \text{verb}(\text{Interlocutor}, \text{Proposed\_action}, \text{Speaker})$ , where Interlocution is the person who proposed the Proposed\_action to the Speaker and to whom the Speaker communicates their response. Proposed\_action is an action that the Speaker would perform if they were to accept or refuse the request or offer, and The Speaker is the person to whom a particular action has been proposed and who responds to the request or offer made.

[0191] In a further example, a similarity between verbs agree and explain is represented as follows:  $\text{agree} \hat{=} \text{explain} = \text{verb}(\text{Interlocutor}, *, \text{Speaker})$ . The subjects of communicative actions are generalized in the context of communicative actions and are not be generalized with other

“physical” actions. Hence, aspects generalize individual occurrences of communicative actions together with corresponding subjects.

[0192] Additionally, sequences of communicative actions representing dialogs can be compared against other such sequences of similar dialogs. In this manner, the meaning of an individual communicative action as well as the dynamic discourse structure of a dialogue is (in contrast to its static structure reflected via rhetoric relations) is represented. A generalization is a compound structural representation that happens at each level. Lemma of a communicative action is generalized with lemma, and its semantic role are generalized with respective semantic role.

[0193] Communicative actions are used by text authors to indicate a structure of a dialogue or a conflict. See Searle, J. R. 1969, Speech acts: an essay in the philosophy of language. London: Cambridge University Press. Subjects are generalized in the context of these actions and are not generalized with other “physical” actions. Hence, the individual occurrences of communicative actions together are generalized with their subjects, as well as their pairs, as discourse “steps.”

[0194] Generalization of communicative actions can also be thought of from the standpoint of matching the verb frames, such as VerbNet. The communicative links reflect the discourse structure associated with participation (or mentioning) of more than a single agent in the text. The links form a sequence connecting the words for communicative actions (either verbs or multi-words implicitly indicating a communicative intent of a person).

[0195] Communicative actions include an actor, one or more agents being acted upon, and the phrase describing the features of this action. A communicative action can be described as a function of the form: verb (agent, subject, cause), where verb characterizes some type of interaction between involved agents (e.g., explain, confirm, remind, disagree, deny, etc.), subject refers to the information transmitted or object described, and cause refers to the motivation or explanation for the subject.

[0196] A scenario (labeled directed graph) is a sub-graph of a parse thicket  $G=(V, A)$ , where  $V=\{\text{action}_1, \text{action}_2, \dots, \text{action}_n\}$  is a finite set of vertices corresponding to communicative actions, and  $A$  is a finite set of labeled arcs (ordered pairs of vertices), classified as follows:

[0197] Each arc  $\text{action}_i, \text{action}_j \in A_{\text{sequence}}$  corresponds to a temporal precedence of two actions  $v_i, ag_i, s_i, c_i$  and  $v_j, ag_j, s_j, c_j$  that refer to the same subject, e.g.,  $s_j=s_i$  or different subjects. Each arc  $\text{action}_i, \text{action}_j \in A_{\text{cause}}$  corresponds to an attack relationship between  $\text{action}_i$  and  $\text{action}_j$  indicating that the cause of  $\text{action}_i$  in conflict with the subject or cause of  $\text{action}_j$ .

[0198] Subgraphs of parse thickets associated with scenarios of interaction between agents have some distinguishing features. For example, (1) all vertices are ordered in time, so that there is one incoming arc and one outgoing arc for all vertices (except the initial and terminal vertices), (2) for  $A_{\text{sequence}}$  arcs, at most one incoming and only one outgoing arc are admissible, and (3) for  $A_{\text{cause}}$  arcs, there can be many outgoing arcs from a given vertex, as well as many incoming arcs. The vertices involved may be associated with different agents or with the same agent (i.e., when he contradicts himself). To compute similarities between parse thickets and their communicative action, induced subgraphs,

the sub-graphs of the same configuration with similar labels of arcs and strict correspondence of vertices are analyzed.

**[0199]** The following similarities exist by analyzing the arcs of the communicative actions of a parse thicket: (1) one communicative action from with its subject from T1 against another communicative action with its subject from T2 (communicative action arc is not used), and (2) a pair of communicative actions with their subjects from T1 compared to another pair of communicative actions from T2 (communicative action arcs are used).

**[0200]** Generalizing two different communicative actions is based on their attributes. See (Galitsky et al 2013). As can be seen in the example discussed with respect to FIG. 14, one communicative action from T1, cheating(husband, wife, another lady) can be compared with a second from T2, avoid(husband, contact(husband, another lady)). A generalization results in communicative\_action(husband, \*) which introduces a constraint on A in the form that if a given agent(=husband) is mentioned as a subject of CA in Q, he/she should also be a subject of (possibly, another) CA in A. Two communicative actions can always be generalized, which is not the case for their subjects: if their generalization result is empty, the generalization result of communicative actions with these subjects is also empty.

#### Generalization of RST Relations

**[0201]** Some relations between discourse trees can be generalized, such as arcs that represent the same type of relation (presentation relation, such as antithesis, subject matter relation, such as condition, and multinuclear relation, such as list) can be generalized. A nucleus or a situation presented by a nucleus is indicated by “N.” Satellite or situations presented by a satellite, are indicated by “S.” “W” indicates a writer. “R” indicates a reader (hearer). Situations are propositions, completed actions or actions in progress, and communicative actions and states (including beliefs, desires, approve, explain, reconcile and others). Generalization of two RST relations with the above parameters is expressed as:

$$rst1(N1, S1, W1, R1) \hat{=} rst2(N2, S2, W2, R2) = \\ (rst1 \hat{=} rst2)(N1 \hat{=} N2, S1 \hat{=} S2, W1 \hat{=} W2, R1 \hat{=} R2).$$

**[0202]** The texts in N1, S1, W1, R1 are subject to generalization as phrases. For example,  $rst1 \hat{=} rst2$  can be generalized as follows: (1) if  $relation\_type(rst1) \neq relation\_type(rst2)$  then a generalization is empty. (2) Otherwise, the signatures of rhetoric relations are generalized as sentences:  $sentence(N1, S1, W1, R1) \hat{=} sentence(N2, S2, W2, R2)$ . See Irukieta, Mikel, Iria da Cunha and Maite Taboada. A qualitative comparison method for rhetorical structures: identifying different discourse structures in multilingual corpora. Lang Resources & Evaluation. June 2015, Volume 49, Issue 2.

**[0203]** For example, the meaning of  $rst-background \hat{=} rst-enablement = (S \text{ increases the ability of } R \text{ to comprehend an element in } N) \hat{=} (R \text{ comprehending } S \text{ increases the ability of } R \text{ to perform the action in } N) = \text{increase-VB the-DT ability-NN of-IN R-NN to-IN}$ .

**[0204]** Because the relations  $rst-background \hat{=} rst-enablement$  differ, the RST relation part is empty. The expressions that are the verbal definitions of respective RST relations are then generalized. For example, for each word or a placeholder for a word such as an agent, this word (with its POS) is retained if the word the same in each input phrase or

remove the word if the word is different between these phrases. The resultant expression can be interpreted as a common meaning between the definitions of two different RST relations, obtained formally.

**[0205]** Two arcs between the question and the answer depicted in FIG. 14 show the generalization instance based on the RST relation “RST-contrast”. For example, “I just had a baby” is a RST-contrast with “it does not look like me,” and related to “husband to avoid contact” which is a RST-contrast with “have the basic legal and financial commitments.” As can be seen, the answer need not have to be similar to the verb phrase of the question but the rhetoric structure of the question and answer are similar. Not all phrases in the answer must match phrases in question. For example, the phrases that do not match have certain rhetoric relations with the phrases in the answer which are relevant to phrases in question.

#### Building a Communicative Discourse Tree

**[0206]** FIG. 15 illustrates an exemplary process for building a communicative discourse tree in accordance with an aspect. Rhetoric classification application 102 can implement process 1500. As discussed, communicative discourse trees enable improved search engine results.

**[0207]** At block 1501, process 1500 involves accessing a sentence comprising fragments. At least one fragment includes a verb and words and each word includes a role of the words within the fragment, and each fragment is an elementary discourse unit. For example, rhetoric classification application 102 accesses a sentence such as “Rebels, the self-proclaimed Donetsk People’s Republic, deny that they controlled the territory from which the missile was allegedly fired” as described with respect to FIG. 13.

**[0208]** Continuing the example, rhetoric classification application 102 determines that the sentence includes several fragments. For example, a first fragment is “rebels . . . deny.” A second fragment is “that they controlled the territory.” A third fragment is “from which the missile was allegedly fired.” Each fragment includes a verb, for example, “deny” for the first fragment and “controlled” for the second fragment. Although, a fragment need not include a verb.

**[0209]** At block 1502, process 1500 involves generating a discourse tree that represents rhetorical relationships between the sentence fragments. The discourse tree including nodes, each nonterminal node representing a rhetorical relationship between two of the sentence fragments and each terminal node of the nodes of the discourse tree is associated with one of the sentence fragments.

**[0210]** Continuing the example, rhetoric classification application 102 generates a discourse tree as shown in FIG. 13. For example, the third fragment, “from which the missile was allegedly fired” elaborates on “that they controlled the territory.” The second and third fragments together relate to attribution of what happened, i.e., the attack cannot have been the rebels because they do not control the territory.

**[0211]** At block 1503, process 1500 involves accessing multiple verb signatures. For example, rhetoric classification application 102 accesses a list of verbs, e.g., from VerbNet. Each verb matches or is related to the verb of the fragment. For example, the for the first fragment, the verb is “deny.” Accordingly, rhetoric classification application 102 accesses a list of verb signatures that relate to the verb deny.

**[0212]** As discussed, each verb signature includes the verb of the fragment and one or more of thematic roles. For

example, a signature includes one or more of noun phrase (NP), noun (N), communicative action (V), verb phrase (VP), or adverb (ADV). The thematic roles describing the relationship between the verb and related words. For example “the teacher amused the children” has a different signature from “small children amuse quickly.” For the first fragment, the verb “deny,” rhetoric classification application 102 accesses a list of frames, or verb signatures for verbs that match “deny.” The list is “NP V NP to be NP,” “NP V that S” and “NP V NP.”

[0213] Each verb signature includes thematic roles. A thematic role refers to the role of the verb in the sentence fragment. Rhetoric classification application 102 determines the thematic roles in each verb signature. Example thematic roles include actor, agent, asset, attribute, beneficiary, cause, location destination source, destination, source, location, experiencer, extent, instrument, material and product, material, product, patient, predicate, recipient, stimulus, theme, time, or topic.

[0214] At block 1504, process 1500 involves determining, for each verb signature of the verb signatures, a number of thematic roles of the respective signature that match a role of a word in the fragment. For the first fragment, rhetorical classification application 102 determines that the verb “deny” has only three roles, “agent”, “verb” and “theme.”

[0215] At block 1505, process 1500 involves selecting a particular verb signature from the verb signatures based on the particular verb signature having a highest number of matches. For example, referring again to FIG. 13, deny in the first fragment “the rebels deny . . . that they control the territory” is matched to verb signature deny “NP V NP”, and “control” is matched to control (rebel, territory). Verb signatures are nested, resulting in a nested signature of “deny (rebel, control(rebel, territory)).”

#### Representing a Request-Response

[0216] Request-response pairs can be analyzed alone or as pairs. In an example, request-response pairs can be chained together. In a chain, rhetoric agreement is expected to hold not only between consecutive members but also triples and four-tuples. A discourse tree can be constructed for a text expressing a sequence of request-response pairs. For example, in the domain of customer complaints, request and response are present in the same text, from the viewpoint of a complainant. Customer complaint text can be split into request and response text portions and then form the positive and negative dataset of pairs. In an example, all text for the proponent and all text for the opponent is combined. The first sentence of each paragraph below will form the Request part (which will include three sentences) and second sentence of each paragraph will form the Response part (which will also include three sentences in this example).

[0217] FIG. 16 illustrates a discourse tree and scenario graph in accordance with an aspect. FIG. 16 depicts discourse tree 1601 and scenario graph 1602. Discourse tree 1601 corresponds to the following three sentences:

[0218] (1) I explained that my check bounced (I wrote it after I made a deposit). A customer service representative accepted that it usually takes some time to process the deposit.

[0219] (2) I reminded that I was unfairly charged an overdraft fee a month ago in a similar situation. They denied that it was unfair because the overdraft fee was disclosed in my account information.

[0220] (3) I disagreed with their fee and wanted this fee deposited back to my account. They explained that nothing can be done at this point and that I need to look into the account rules closer.

[0221] As can be seen by the discourse tree in FIG. 16, determining whether the text represents an interaction or a description can be hard to judge. Hence, by analyzing the arcs of communicative actions of a parse thicket, implicit similarities between texts can be found. For example, in general terms:

[0222] (1) one communicative actions from with its subject from a first tree against another communicative action with its subject from a second tree (communicative action arc is not used).

[0223] (2) a pair of communicative actions with their subjects from a first tree against another pair of communicative actions from a second tree (communicative action arcs are used).

[0224] For example, in the previous example, the generalization of cheating(husband, wife, another lady) avoid (husband, contact(husband, another lady)) provides us communicative action(husband, \*) which introduces a constraint on A in the form that if a given agent(=husband) is mentioned as a subject of CA in Q, he/she) should also be a subject of (possibly, another) CA in A.

[0225] To handle meaning of words expressing the subjects of CAs, a word can be applied to a vector model such as the “word2vector” model. More specifically, to compute generalization between the subjects of communicative actions, the following rule can be used: if subject1=subject2, subject1^subject2=<subject1, POS(subject1), 1>. Here subject1 remains and score is 1. Otherwise, if the subjects have the same part-of-speech (POS), then subject1^subject2=<\*, POS(subject1), word2vecDistance(subject1^subject2)>. ‘\*’ denotes that lemma is a placeholder, and the score is a word2vec distance between these words. If POS is different, generalization is an empty tuple and may not be further generalized.

#### Classification settings for Request-Response Pairs

[0226] In a conventional search, as a baseline, the match between request response pairs can be measured in terms of keyword statistics such as short for term frequency-inverse document frequency (TF\*IDF). To improve search relevance, this score is augmented by item popularity, item location or taxonomy-based score (Galitsky 2015). Search can also be formulated as a passage re-ranking problem in machine learning framework. The feature space includes request-response pairs as elements, and a separation hyperplane splits this feature space into correct and incorrect pairs. Hence a search problem can be formulated in a local way, as similarity between Req and Resp, or in a global, learning way, via similarity between request-response pairs.

[0227] Other methods are possible for determining a match between request and response. In a first example, rhetoric classification application 102 extracts features for Req and Resp and compares the features as a count, introducing a scoring function such that a score would indicate a class (low score for incorrect pairs, high score for correct ones)

[0228] In a second example, rhetoric classification application 102 compares representations for Req and Resp against each other, and assigns a score for the comparison result. Analogously, the score will indicate a class.

[0229] In a third example, rhetoric classification application 102 builds a representation for a pair Req and Resp, <Req, Resp> as elements of training set. Rhetoric classification application 102 then performs learning in the feature space of all such elements <Req, Resp>.

[0230] FIG. 17 illustrates forming a request-response pair in accordance with an aspect. FIG. 17 depicts request-response pair 1701, request tree (or object) 1702, and response tree 1703. To form a <Req, Resp> object, the rhetoric classification application 102 combines the discourse tree for the request and the discourse tree for the response into a single tree with the root RR. The rhetoric classification application 102 then classifies the objects into correct (with high agreement) and incorrect (with low agreement) categories.

#### Nearest Neighbor Graph-Based Classification

[0231] Once a CDT is built, in order to identify an argument in text, rhetoric classification application 102 compute the similarity compared to CDTs for the positive class and verify that it is lower to the set of CDTs for its negative class. Similarity between CDT is defined by means of maximal common sub-CDTs.

[0232] In an example, an ordered set G of CDTs(V,E) with vertex- and edge-labels from the sets  $(\Lambda_v, \leq)$  and  $(\Lambda_e, \leq)$  is constructed. A labeled CDT F from G is a pair of pairs of the form  $((V,I),(E,b))$ , where V is a set of vertices, E is a set of edges,  $I: V \rightarrow \Lambda_v$  is a function assigning labels to vertices, and  $b: E \rightarrow \Lambda_e$  is a function assigning labels to edges. Isomorphic trees with identical labeling are not distinguished.

[0233] The order is defined as follows: For two CDTs  $\Gamma_1 := ((V_1, I_1), (E_1, b_1))$  and  $\Gamma_2 := ((V_2, I_2), (E_2, b_2))$  from G, then that  $\Gamma_1$  dominates  $\Gamma_2$  or  $\Gamma_2 < \Gamma_1$  (or  $\Gamma_2$  is a sub-CDT of  $\Gamma_1$ ) if there exists a one-to-one mapping  $\varphi: V_2 \rightarrow V_1$  such that it (1) respects edges:  $(v,w) \in E_2 \Rightarrow (\varphi(v), \varphi(w)) \in E_1$ , and (2) fits under labels:  $I_2(v) \leq I_1(\varphi(v))$ ,  $(v,w) \in E_2 \Rightarrow b_2(v,w) \leq b_1(\varphi(v), \varphi(w))$ .

[0234] This definition takes into account the calculation of similarity (“weakening”) of labels of matched vertices when passing from the “larger” CDT  $G_1$  to “smaller” CDT  $G_2$ .

[0235] Now, similarity CDT Z of a pair of CDTs X and Y, denoted by  $X \wedge Y = Z$ , is the set of all inclusion-maximal common sub-CDTs of X and Y, each of them satisfying the following additional conditions (1) to be matched, two vertices from CDTs X and Y must denote the same RST relation; and (2) each common sub-CDT from Z contains at least one communicative action with the same VerbNet signature as in X and Y.

[0236] This definition is easily extended to finding generalizations of several graphs. The subsumption order  $\mu$  on pairs of graph sets X and Y is naturally defined as  $X \mu Y := X \wedge Y = X$ .

[0237] FIG. 18 illustrates a maximal common sub-communicative discourse tree in accordance with an aspect. Notice that the tree is inverted and the labels of arcs are generalized: Communicative action site( ) is generalized with communicative action say( ). The first (agent) argument of the former CA committee is generalized with the first argument of the latter CA Dutch. The same operation is applied to the second arguments for this pair of CAs: investigator^evidence.

[0238] CDT U belongs to a positive class such that (1) U is similar to (has a nonempty common sub-CDT) with a

positive example  $R^+$  and (2) for any negative example  $R^-$ , if U is similar to  $R^-$  (i.e.,  $U * R^- \neq \emptyset$ ) then  $U * R^- \mu U * R^+$ .

[0239] This condition introduces the measure of similarity and says that to be assigned to a class, the similarity between the unknown CDT U and the closest CDT from the positive class should be higher than the similarity between U and each negative example. Condition 2 implies that there is a positive example  $R^+$  such that for no  $R^-$  one has  $U * R^+ \mu R^-$ , i.e., there is no counterexample to this generalization of positive examples.

Thicket Kernel learning for CDT

[0240] Tree Kernel learning for strings, parse trees and parse thickets is a well-established research area these days. The parse tree kernel counts the number of common subtrees as the discourse similarity measure between two instances. Tree kernel has been defined for DT by Joty, Shafiq and A. Moschitti. Discriminative Reranking of Discourse Parses Using Tree Kernels. Proceedings of EMNLP. (2014). See also Wang, W., Su, J., & Tan, C. L. (2010). Kernel Based Discourse Relation Recognition with Temporal Ordering Information. In Proceedings of the 48th Annual Meeting of the Association for Computational Linguistics. (using the special form of tree kernels for discourse relation recognition). A thicket kernel is defined for a CDT by augmenting a DT kernel by the information on communicative actions. A CDT can be represented by a vector V of integer counts of each sub-tree type (without taking into account its ancestors):  $V(T) = (\# \text{ of subtrees of type } 1, \dots, \# \text{ of subtrees of type } 1, \dots, \# \text{ of subtrees of type } n)$ . This results in a very high dimensionality since the number of different sub-trees is exponential in its size. Thus, it is computational infeasible to directly use the feature vector  $\emptyset(T)$ . To solve the computational issue, a tree kernel function is introduced to calculate the dot product between the above high dimensional vectors efficiently. Given two tree segments CDT1 and CDT2, the tree kernel function is defined:

$$K(CDT1, CDT2) = \sum_i V(CDT1)_i V(CDT2)_i = \sum_{n1} \sum_{n2} \sum_i I_i(n1) * I_i(n2) \text{ where}$$

[0241]  $n1 \in N1$ ,  $n2 \in N2$  where  $N1$  and  $N2$  are the sets of all nodes in CDT1 and CDT2, respectively;

[0242]  $I_i(n)$  is the indicator function.

[0243]  $I_i(n) = \{1 \text{ iff a subtree of type } i \text{ occurs with root at node; } 0 \text{ otherwise}\}$ .  $K(CDT1, CDT2)$  is an instance of convolution kernels over tree structures (Collins and Duffy, 2002) and can be computed by recursive definitions:

$$\Delta(n1, n2) = \sum I_i(n1) * I_i(n2)$$

[0244]  $\Delta(n1, n2) = 0$  if  $n1$  and  $n2$  are assigned the same POS tag or their children are different subtrees.

[0245] Otherwise, if both  $n1$  and  $n2$  are POS tags (are pre-terminal nodes) then  $\Delta(n1, n2) = 1 \times \lambda$ ;

[0246] Otherwise,  $\Delta(n1, n2) = \lambda \prod_{j=1}^{nc(n1)} (1 + \Delta(\text{ch}(n1, j), \text{ch}(n2, j)))$

where  $\text{ch}(n, j)$  is the  $j$ th child of node  $n$ ,  $nc(n_1)$  is the number of the children of  $n_1$ , and  $\lambda (0 < \lambda < 1)$  is the decay factor in order to make the kernel value less variable with respect to the sub-tree sizes. In addition, the recursive rule (3) holds because given two nodes with the same children, one can construct common sub-trees using these children and common sub-trees of further offspring. The parse tree kernel counts the number of common sub-trees as the syntactic similarity measure between two instances.

[0247] FIG. 19 illustrates a tree in a kernel learning format for a communicative discourse tree in accordance with an aspect.

[0248] The terms for Communicative Actions as labels are converted into trees which are added to respective nodes for RST relations. For texts for EDUs as labels for terminal nodes only the phrase structure is retained. The terminal nodes are labeled with the sequence of phrase types instead of parse tree fragments.

[0249] If there is a rhetoric relation arc from a node X to a terminal EDU node Y with label A(B, C(D)), then the subtree A-B→(C-D) is appended to X.

#### Implementation of the Rhetoric Agreement Classifier

[0250] Rhetoric agreement classifier 120 can determine the complementarity between two sentences, such as a question and an answer, by using communicative discourse trees. FIG. 20 illustrates an exemplary process used to implement a rhetoric agreement classifier in accordance with an aspect. FIG. 20 depicts process 2000, which can be implemented by rhetoric classification application 102. As discussed, rhetoric agreement classifier 120 is trained with training data 125.

[0251] Rhetoric agreement classifier 120 determines a communicative discourse tree for both question and answer. For example, rhetoric agreement classifier 120 constructs question communicative discourse tree 110 from a question such as question 171 or input text 130, and answer communicative discourse tree 111 from a candidate answer.

[0252] At block 2001, process 2000 involves determining, for a question sentence, a question communicative discourse tree including a question root node. A question sentence can be an explicit question, a request, or a comment. Rhetoric classification application 102 creates question communicative discourse tree 110 from input text 130. Using the example discussed in relation to FIGS. 13 and 15, an example question sentence is “are rebels responsible for the downing of the flight.” Rhetoric classification application 102 can use process 1500 described with respect to FIG. 15. The example question has a root node of “elaborate.”

[0253] At block 2002, process 2000 involves determining, for an answer sentence, a second communicative discourse tree, wherein the answer communicative discourse tree includes an answer root node. Continuing the above example, rhetoric classification application 102 creates an communicative discourse tree 111, as depicted in FIG. 13, which also has a root node “elaborate.”

[0254] At block 2003, process 2000 involves associating the communicative discourse trees by identifying that the question root node and the answer root node are identical. Rhetoric classification application 102 determines that the question communicative discourse tree 110 and answer communicative discourse tree 111 have an identical root node. The resulting associated communicative discourse tree is depicted in FIG. 17 and can be labeled as a “request-response pair.”

[0255] At block 2004, process 2000 involves computing a level of complementarity between the question communicative discourse tree and the answer communicative discourse tree by applying a predictive model to the merged discourse tree.

[0256] The rhetoric agreement classifier uses machine learning techniques. In an aspect, the rhetoric classification application 102 trains and uses rhetoric agreement classifier

120. For example, rhetoric classification application 102 defines positive and negative classes of request-response pairs. The positive class includes rhetorically correct request-response pairs and the negative class includes relevant but rhetorically foreign request-response pairs.

[0257] For each request-response pair, the rhetoric classification application 102 builds a CDT by parsing each sentence and obtaining verb signatures for the sentence fragments.

[0258] Rhetoric classification application 102 provides the associated communicative discourse tree pair to rhetoric agreement classifier 120. Rhetoric agreement classifier 120 outputs a level of complementarity.

[0259] At block 2005, process 2000 involves responsive to determining that the level of complementarity is above a threshold, identifying the question and answer sentences as complementary. Rhetoric classification application 102 can use a threshold level of complementarity to determine whether the question-answer pair is sufficiently complementary. For example, if a classification score is greater than a threshold, then rhetoric classification application 102 can output the answer as answer 172 or answer 150. Alternatively, rhetoric classification application 102 can discard the answer and access answer database 105 or a public database for another candidate answer and repeat process 2000 as necessary.

[0260] In an aspect, the rhetoric classification application 102 obtains co-references. In a further aspect, the rhetoric classification application 102 obtains entity and sub-entity, or hyponym links. A hyponym is a word of more specific meaning than a general or superordinate term applicable to the word. For example, “spoon” is a hyponym of “cutlery.”

[0261] In another aspect, rhetoric classification application 102 applies thicket kernel learning to the representations. Thicket kernel learning can take place in place of classification-based learning described above, e.g., at block 2004. The rhetoric classification application 102 builds a parse thicket pair for the parse tree of the request-response pair. The rhetoric classification application 102 applies discourse parsing to obtain a discourse tree pair for the request-response pair. The rhetoric classification application 102 aligns elementary discourse units of the discourse tree request-response and the parse tree request-response. The rhetoric classification application 102 merges the elementary discourse units of the discourse tree request-response and the parse tree request-response.

[0262] In an aspect, rhetoric classification application 102 improves the text similarity assessment by word2vector model.

[0263] In a further aspect, rhetoric classification application 102 sends a sentence that corresponds to the question communicative discourse tree 110 or a sentence that corresponds to the answer communicative discourse tree to a device such as mobile device 170. Outputs from rhetoric classification application 102 can be used as inputs to search queries, database lookups, or other systems. In this manner, rhetoric classification application 102 can integrate with a search engine system.

[0264] FIG. 21 illustrates a chat bot commenting on a posting in accordance with an aspect. FIG. 21 depicts chat 2100, user messages 2101-2104, and agent response 2105. Agent response 2105 can be implemented by the rhetoric

classification application 102. As shown, agent response 2105 has identified a suitable answer to the thread of user messages 2101-2104.

[0265] FIG. 22 illustrates a chat bot commenting on a posting in accordance with an aspect. FIG. 22 depicts chat 2200, user messages 2201-2205, and agent response 2206. FIG. 22 depicts three messages from user 1, specifically 2201, 2203, and 2205, and two messages from user 2, specifically 2202 and 2204. Agent response 2206 can be implemented by the rhetoric classification application 102. As shown, agent response 2106 has identified a suitable answer to the thread of messages 2201-2204.

[0266] The features depicted in FIGS. 21 and 22 can be implemented by rhetoric classification computing device 101, or by a device that provides input text 130 to rhetoric classification computing device 101 and receives answer 150 from rhetoric classification computing device 101.

#### Additional Rules for RR Agreement and RR Irrationality

[0267] The following are the examples of structural rules which introduce constraint to enforce RR agreement:

[0268] 1. Both Req and Resp have the same sentiment polarity (If a request is positive the response should be positive as well, and other way around.

[0269] 2. Both Req and Resp have a logical argument.

[0270] Under rational reasoning, Request and Response will fully agree: a rational agent will provide an answer which will be both relevant and match the question rhetoric. However, in the real world not all responses are fully rational. The body of research on Cognitive biases explores human tendencies to think in certain ways that can lead to systematic deviations from a standard of rationality or good judgment.

[0271] The correspondence bias is the tendency for people to over-emphasize personality-based explanations for behaviors observed in others, responding to questions. See Baumeister, R. F. & Bushman, B. J. Social psychology and human nature: International Edition. (2010). At the same time, those responding queries under-emphasize the role and power of situational influences on the same behavior.

[0272] Confirmation bias, the inclination to search for or interpret information in a way that confirms the preconceptions of those answering questions. They may discredit information that does not support their views. The confirmation bias is related to the concept of cognitive dissonance. Whereby, individuals may reduce inconsistency by searching for information which re-confirms their views.

[0273] Anchoring leads to relying too heavily, or “anchor”, on one trait or piece of information when making decisions.

[0274] Availability heuristic makes us overestimate the likelihood of events with greater “availability” in memory, which can be influenced by how recent the memories are or how unusual or emotionally charged they may be.

[0275] According to Bandwagon effect, people answer questions believing in things because many other people do (or believe) the same.

[0276] Belief bias is an effect where someone’s evaluation of the logical strength of an argument is biased by the believability of the conclusion.

[0277] Bias blind spot is the tendency to see oneself as less biased than other people, or to be able to identify more cognitive biases in others than in oneself.

#### Evaluation

[0278] A first domain of test data is derived from question-answer pairs from Yahoo! Answers, which is a set of question-answer pairs with broad topics. Out of the set of 4.4 million user questions, 20000 are selected that each include more than two sentences. Answers for most questions are fairly detailed so no filtering was applied to answers. There are multiple answers per questions and the best one is marked. We consider the pair Question-Best Answer as an element of the positive training set and Question-Other-Answer as the one of the negative training set. To derive the negative set, we either randomly select an answer to a different but somewhat related question, or formed a query from the question and obtained an answer from web search results.

[0279] Our second dataset includes the social media. We extracted Request-Response pairs mainly from postings on Facebook. We also used a smaller portion of LinkedIn.com and vk.com conversations related to employment. In the social domains the standards of writing are fairly low. The cohesiveness of text is very limited and the logical structure and relevance frequently absent. The authors formed the training sets from their own accounts and also public Facebook accounts available via API over a number of years (at the time of writing Facebook API for getting messages is unavailable). In addition, we used 860 email threads from Enron dataset. Also, we collected the data of manual responses to postings of an agent which automatically generates posts on behalf of human users-hosts. See Galitsky B., Dmitri Ilvovsky, Nina Lebedeva and Daniel Usikov. Improving Trust in Automation of Social Promotion. AAAI Spring Symposium on The Intersection of Robust Intelligence and Trust in Autonomous Systems Stanford CA 2014. (“Galitsky 2014”). We formed 4000 pairs from the various social network sources.

[0280] The third domain is customer complaints. In a typical complaint a dissatisfied customer describes his problems with products and service as well as the process for how he attempted to communicate these problems with the company and how they responded. Complaints are frequently written in a biased way, exaggerating product faults and presenting the actions of opponents as unfair and inappropriate. At the same time, the complainants try to write complaints in a convincing, coherent and logically consistent way (Galitsky 2014); therefore complaints serve as a domain with high agreement between requests and response. For the purpose of assessing agreement between user complaint and company response (according to how this user describes it) we collected 670 complaints from planetfeedback.com over 10 years.

[0281] The fourth domain is interview by journalist. Usually, the way interviews are written by professional journalists is such that the match between questions and answers is very high. We collected 1200 contributions of professional and citizen journalists from such sources as datran.com, allvoices.com, huffingtonpost.com and others.

[0282] To facilitate data collection, we designed a crawler which searched a specific set of sites, downloaded web pages, extracted candidate text and verified that it adhered to a question-or-request vs response format. Then the respective pair of text is formed. The search is implemented via Bing Azure Search Engine API in the Web and News domains.

[0283] Recognizing valid and invalid answers



**[0284]** Answer classification accuracies are shown in Table 1. Each row represents a particular method; each class of methods is shown in grayed areas.

**[0288]** Employing TK family of approaches based on CDT gives us the accuracy comparable to the one achieved in classifying DT as correct and incorrect, the rhetoric

TABLE 1

Source/ Evaluation	Evaluation results											
	Yahoo! Answers			Conversation on Social Networks			Customer complaints			Interviews by Journalists		
	P	R	F1	P	R	F1	P	R	F1	P	R	F1
Types and counts for rhetoric relations of Req and Resp	55.2	52.9	54.03	51.5	52.4	51.95	54.2	53.9	54.05	53	55.5	54.23
Entity-based alignment of DT of Req-Resp	63.1	57.8	6.33	51.6	58.3	54.7	48.6	57.0	52.45	59.2	57.9	53.21
Maximal common sub-DT fo Req and Resp	67.3	64.1	65.66	70.2	61.2	65.4	54.6	60.0	57.16	80.2	69.8	74.61
Maximal common sub-CDT for Req and Resp	68.1	67.2	67.65	68.0	63.8	65.83	58.4	62.8	60.48	77.6	67.6	72.26
SVM TK for Parse Trees of individual sentences	66.1	63.8	64.93	69.3	64.4	66.8	46.7	61.9	53.27	78.7	66.8	72.24
SVM TK for RST and CA (full parse trees)	75.8	74.2	74.99	72.7	77.7	75.11	63.5	74.9	68.74	75.7	84.5	79.83
SVM TK for RR- DT	76.5	77	76.75	74.4	71.8	73.07	64.2	69.4	66.69	82.5	69.4	75.4
SVM TK for RR- CDT	80.3	78.3	79.29	78.6	82.1	80.34	59.5	79.9	68.22	82.7	80.9	81.78
SVM TK for RR- CDT + sentiment + argumentation features	78.3	76.9	77.59	67.5	69.3	68.38	55.8	65.9	60.44	76.5	74.0	75.21

**[0285]** One can see that the highest accuracy is achieved in journalism and community answers domain and the lowest in customer complaints and social networks. We can conclude that the higher is the achieved accuracy having the method fixed, the higher is the level of agreement between Req and Resp and correspondingly the higher the responder's competence.

**[0286]** Deterministic family of approaches (middle two rows, local RR similarity-based classification) performs about 9% below SVM TK which indicates that similarity between Req and Resp is substantially less important than certain structures of RR pairs indicative of an RR agreement. It means that agreement between Req and Resp cannot be assessed on the individual basis: if we demand DT(Req) be very similar to DT(Resp) we will get a decent precision but extremely low recall. Proceeding from DT to CDT helps by 1-2% only, since communicative actions play a major role in neither composing a request nor forming a response.

**[0287]** For statistical family of approaches (bottom 5 rows, tree kernels), the richest source of discourse data (SVM TK for RR-DT) gives the highest classification accuracy, almost the same as the RR similarity-based classification. Although SVM TK for RST and CA (full parse trees) included more linguistic data, some part of it (most likely, syntactic) is redundant and gives lower results for the limited training set. Using additional features under TK such as sentiment and argumentation does not help either: most likely, these features are derived from RR-CDT features and do not contribute to classification accuracy on their own.

parsing tasks where the state-of-the-art systems meet a strong competition over last few years and derived over 80% accuracy.

**[0289]** Direct analysis approaches in the deterministic family perform rather weakly, which means that a higher number and a more complicated structure of features is required: just counting and taking into account types of rhetoric relations is insufficient to judge on how RR agree with each other. If two RR pairs have the same types and counts of rhetoric relations and even communicative actions they can still belong to opposite RR agreement classes in the majority of cases.

**[0290]** Nearest-pair neighbor learning for CDT achieves lower accuracy than SVM TK for CDT, but the former gives interesting examples of sub-trees which are typical for argumentation, and the ones which are shared among the factoid data. The number of the former groups of CDT sub-trees is naturally significantly higher. Unfortunately SVM TK approach does not help to explain how exactly the RR agreement problem is solved: it only gives final scoring and class labels. It is possible but infrequent to express a logical argument in a response without communicative actions (this observation is backed up by our data).

#### Measuring RR Agreement in Evaluation Domains

**[0291]** From the standpoint of evaluation of recognition accuracy, we obtained the best method in the previous subsection. Now, having this method fixed, we will measure RR agreements in our evaluation domains. We will also

show how the general, total agreement delivered by the best method is correlated with individual agreement criteria such as sentiment, logical argumentation, topics and keyword relevance. Once we use our best approach (SVM TK for RR-CDT) for labeling training set, the size of it can grow dramatically and we can explore interesting properties of RR agreement in various domains. We will discover the contribution of a number of intuitive features of RR agreement on a larger dataset than the previous evaluation.

**[0292]** In this Subsection we intend to demonstrate that the RR pair validity recognition framework can serve as a measure of agreement between an arbitrary request and response. Also, this recognition framework can assess how strongly various features are correlated with RR pair validity.

**[0293]** From the evaluation of recognition accuracy, we obtained the best method to recognize of the RR pair is valid or not. Now, having this recognition method fixed, we will measure RR agreements in our evaluation domains, and will also estimate how a general, total agreement delivered by the best method is correlated with individual agreement criteria such as sentiment, logical argumentation, topics and keyword relevance. Once we use our best approach (SVM TK for RR-CDT) for labeling training set, the size of it can grow dramatically and we can explore interesting properties of RR agreement in various domains. We will discover on a larger dataset than the previous evaluation, the contribution of a number of intuitive features of RR agreement. We will measure this agreement on a feature-by-feature basis, on a positive training dataset of above evaluation only, as a recognition precision (%), Table 2). Notice that recall and the negative dataset is not necessary for the assessment of agreement.

TABLE 2

Measure of agreement between request and response in four domains, %				
	Yahoo! Answers	Conversation on Social Networks	Customer Complaints	Interview by Journalists
Overall level of agreement between requests and response, as determined by SVM TK for RR-CDT	87.2	73.4	67.4	100
Agreement by sentiment	61.2	57.3	60.7	70.1
Agreement by logical argumentation	62.5	60.8	58.4	66.0
Agreement by topic as computed by bag-of-words	67.4	67.9	64.3	82.1
Agreement by topic as computed by generalization of parse trees	80.2	69.4	66.2	87.3
Agreement by TK similarity	79.4	70.3	64.7	91.6

**[0294]** For example, we estimate as 64.3% the precision of the observation that the RR pairs determined by Agreement by topic as computed by bag-of-words approach are valid RR ones in the domain of Customer Complaints, according to SVM TK for RR-CDT classification.

**[0295]** Agreement by sentiment shows the contribution of proper sentiment match in RR pair. The sentiment rule

includes, in particular, that if the polarity of RR is the same, response should confirm what request is saying. Conversely, if polarity is opposite, response should attack what request is claiming. Agreement by logical argumentation requires proper communication discourse where a response disagrees with the claim in request.

**[0296]** This data shed a light on the nature of linguistic agreement between what a proponent is saying and how an opponent is responding. For a valid dialogue discourse, not all agreement features need to be present. However, if most of these features disagree, a given answer should be considered invalid, inappropriate and another answer should be selected. Table 2 tells us which features should be used in what degree in dialogue support in various domains. The proposed technique can therefore serve as an automated means of writing quality and customer support quality assessment.

#### Chat Bot Applications

**[0297]** A Conversational Agent for Social Promotion (CASP), is an agent that is presented as a simulated human character which acts on behalf of its human host to facilitate and manage her communication for him or her. Galitsky B., Dmitri Ilvovsky, Nina Lebedeva and Daniel Usikov. Improving Trust in Automation of Social Promotion. AAAI Spring Symposium on The Intersection of Robust Intelligence and Trust in Autonomous Systems Stanford CA 2014. The CASP relieves its human host from the routine, less important activities on social networks such as sharing news and commenting on messages, blogs, forums, images and videos of others. Conversational Agent for Social Promotion evolves with possible loss of trust. The overall performance of CASP with the focus on RR pair agreement, filtering replies mined from the web is evaluated.

**[0298]** On average, people have 200-300 friends or contacts on social network systems such Facebook and LinkedIn. To maintain active relationships with this high number of friends, a few hours per week is required to read what they post and comment on it. In reality, people only maintain relationship with 10-20 most close friends, family and colleagues, and the rest of friends are being communicated with very rarely. These not so close friends feel that the social network relationship has been abandoned. However, maintaining active relationships with all members of social network is beneficial for many aspects of life, from work-related to personal. Users of social network are expected to show to their friends that they are interested in them, care about them, and therefore react to events in their lives, responding to messages posted by them. Hence users of social network need to devote a significant amount of time to maintain relationships on social networks, but frequently do not possess the time to do it. For close friends and family, users would still socialize manually. For the rest of the network, they would use CASP for social promotion being proposed.

**[0299]** CASP tracks user chats, user postings on blogs and forums, comments on shopping sites, and suggest web documents and their snippets, relevant to a purchase decisions. To do that, it needs to take portions of text, produce a search engine query, run it against a search engine API such as Bing, and filter out the search results which are determined to be irrelevant to a seed message. The last step is critical for a sensible functionality of CASP, and poor

relevance in rhetoric space would lead to lost trust in it. Hence an accurate assessment of RR agreement is critical to a successful use of CASP.

**[0300]** CASP is presented as a simulated character that acts on behalf of its human host to facilitate and manage her communication for her (FIGS. 21-22). The agent is designed to relieve its human host from the routine, less important activities on social networks such as sharing news and commenting on messages, blogs, forums, images and videos of others. Unlike the majority of application domains for simulated human characters, its social partners do not necessarily know that they exchange news, opinions, and updates with an automated agent. We experimented with CASP's rhetoric agreement and reasoning about mental states of its peers in a number of Facebook accounts. We evaluate its performance and accuracy of reasoning about mental states involving the human users communicating with it. For a conversational system, users need to feel that it properly reacts to their actions, and that what it replied makes sense. To achieve this in a horizontal domain, one needs to leverage linguistic information to a full degree to be able to exchange messages in a meaningful manner.

**[0301]** CASP inputs a seed (a posting written by a human) and outputs a message it forms from a content mined on the web and adjusted to be relevant to the input posting. This relevance is based on the appropriateness in terms of content and appropriateness in terms RR agreement, or a mental state agreement (for example, it responds by a question to a question, by an answer to a recommendation post seeking more questions, etc.).

**[0302]** FIGS. 21-22 illustrate a chat bot commenting on a posting.

**[0303]** We conduct evaluation of how human users lose trust in CASP and his host in case of both content and mental state relevance failures. Instead of evaluating rhetoric relevance, which is an intermediate parameter in terms of system usability, we assess how users lose trust in CASP when they are annoyed by its rhetorically irrelevant and inappropriate postings.

TABLE 3

Evaluation results for trust losing scenarios					
Topic of the seed	Complexity of the seed and posted message	A friend complains of CASP's host	A friend unfriends the CASP host	A friend shares with other friends that the trust in CASP is low	A friend encourages other friends to unfriend a friend with CASP
Travel and outdoor	1 sent	6.2	8.5	9.4	12.8
	2 sent	6.0	8.9	9.9	11.4
	3 sent	5.9	7.4	10.0	10.8
	4 sent	5.2	6.8	9.4	10.8
Shopping	1 sent	7.2	8.4	9.9	13.1
	2 sent	6.8	8.7	9.4	12.4
	3 sent	6.0	8.4	10.2	11.6
	4 sent	5.5	7.8	9.1	11.9
Events and entertainment	1 sent	7.3	9.5	10.3	13.8
	2 sent	8.1	10.2	10.0	13.9
	3 sent	8.4	9.8	10.8	13.7
	4 sent	8.7	10.0	11.0	13.8
Job-related	1 sent	3.6	4.2	6.1	6.0
	2 sent	3.5	3.9	5.8	6.2
	3 sent	3.7	4.0	6.0	6.4
	4 sent	3.2	3.9	5.8	6.2

TABLE 3-continued

Evaluation results for trust losing scenarios					
Topic of the seed	Complexity of the seed and posted message	A friend complains of CASP's host	A friend unfriends the CASP host	A friend shares with other friends that the trust in CASP is low	A friend encourages other friends to unfriend a friend with CASP
Personal Life	1 sent	7.1	7.9	8.4	9.0
	2 sent	6.9	7.4	9.0	9.5
	3 sent	5.3	7.6	9.4	9.3
	4 sent	5.9	6.7	7.5	8.9
Average		6.03	7.5	8.87	10.58

**[0304]** In Table 3 we show the results of tolerance of users to the CASP failures. After a certain number of failures, friends lose trust and complain, unfriend, shares negative information about the loss of trust with others and even encourage other friends to unfriend a friend who is enabled with CASP. The values in the cell indicate the average number of postings with failed rhetoric relevance when the respective event of lost trust occurs. These posting of failed relevance occurred within one months of this assessment exercise, and we do not obtain the values for the relative frequency of occurrences of these postings. On average, 100 postings were responded for each user (1-4 per seed posting).

**[0305]** One can see that in various domains the scenarios where users lose trust in CASP are different. For less information-critical domains like travel and shopping, tolerance to failed relevance is relatively high.

**[0306]** Conversely, in the domains taken more seriously, like job related, and with personal flavor, like personal life, users are more sensitive to CASP failures and the lost of trust in its various forms occur faster.

**[0307]** For all domains, tolerance slowly decreases when the complexity of posting increases. Users' perception is worse for longer texts, irrelevant in terms of content or their expectations, than for shorter, single sentence or phrase postings by CASP.

#### A Domain of Natural Language Description of Algorithms

**[0308]** The ability to map natural language to a formal query or command language is critical to developing more user-friendly interfaces to many computing systems such as databases. However, relatively little research has addressed the problem of learning such semantic parsers from corpora of sentences paired with their formal-language equivalents. Kate, Rohit., Y. W. Wong, and R. Mooney. Learning to transform natural to formal languages. In *AAAI, 2005*. Furthermore, to the best of our knowledge no such research was conducted at discourse level. By learning to transform natural language (NL) to a complete formal language, NL interfaces to complex computing and AI systems can be more easily developed.

**[0309]** More than 40 years ago, Dijkstra, a Dutch computer scientist who invented the concept of "structured programming", wrote: "I suspect that machines to be programmed in our native tongues—be it Dutch, English, American, French, German, or Swahili—are as damned difficult to make as they would be to use". The visionary was definitely right—the specialization and the high accuracy of

programming languages are what made possible the tremendous progress in the computing and computers as well. Dijkstra compares the invention of programming languages with invention of mathematical symbolism. In his words “Instead of regarding the obligation to use formal symbols as a burden, we should regard the convenience of using them as a privilege: thanks to them, school children can learn to do what in earlier days only genius could achieve”. But four decades years later we keep hitting a wall with the amount of code sitting in a typical industry applications—tens and hundreds of millions lines of code—a nightmare to support and develop. The idiom “The code itself is the best description” became kind of a bad joke.

**[0310]** Natural language descriptions of programs is an area where text rhetoric is peculiar and agreement between statements is essential. We will look at the common rhetoric representation and also domain-specific representation which maps algorithm description into software code.

**[0311]** FIG. 23 illustrates a discourse tree for algorithm text in accordance with an aspect. We have the following text and its DT (FIG. 23):

**[0312]** 1) Find a random pixel p1.

**[0313]** 2) Find a convex area a off this pixel p1 belongs so that all pixels are less than 128.

**[0314]** 3) Verify that the border of the selected area has all pixels above 128.

**[0315]** 4) If the above verification succeeds, stop with positive result. Otherwise, add all pixels which are below 128 to the a off.

**[0316]** 5) Check that the size of a off is below the threshold. Then go to 2. Otherwise, stop with negative result.

**[0317]** We now show how to convert a particular sentence into logic form and then to software code representation. Certain rhetoric relations help to combine statements obtained as a result of translation of individual sentences.

**[0318]** Verify that the border of the selected area has all pixels above 128.

**[0319]** FIG. 24 illustrates annotated sentences in accordance with an aspect. See FIG. 24 for annotated deconstructions of the pseudocode, 1-1 through 1-3.

**[0320]** Converting all constants into variables, we attempt to minimize the number of free variables, and not over-constrain the expression at the same time. Coupled (linked by the edge) arrows show that the same constant values (pixel) are mapped into equal variables (Pixel), following the conventions of logic programming. To achieve this, we add (unary) predicates which need to constrain free variables.

**[0321]** 1-4) Adding Predicates which Constrain Free Variables

**[0322]** epistemic\_action(verify) & border(Area) & border(Pixel) & above(Pixel, 128) & area(Area)

**[0323]** Now we need to build an explicit expression for quantification all. In this particular case it will not be in use, since we use a loop structure anyway

**[0324]** FIG. 25 illustrates annotated sentences in accordance with an aspect. See FIG. 25 for annotated deconstructions of the pseudocode, 1-5 through 2-3.

**[0325]** Finally, we have

2-3) Resultant Code Fragment

**[0326]**

---

```
while (!(Pixel.next( )==null)) {
  if !(border.belong(Pixel) && Pixel.above(128)){
    bOn=false;
    break;
  }
}
Return bOn;
```

---

Related Work

**[0327]** Although discourse analysis has a limited number of applications in question answering and summarization and generation of text, we have not found applications of automatically constructed discourse trees. We enumerate research related to applications of discourse analysis to two areas: dialogue management and dialogue games. These areas have potential of being applied to the same problems the current proposal is intended for. Both of these proposals have a series of logic-based approaches as well as analytical and machine learning based ones.

Managing Dialogues and Question Answering

**[0328]** If a question and answer are logically connected, their rhetoric structure agreement becomes less important.

**[0329]** De Boni proposed a method of determining the appropriateness of an answer to a question through a proof of logical relevance rather than a logical proof of truth. See De Boni, Marco, Using logical relevance for question answering, *Journal of Applied Logic*, Volume 5, Issue 1, March 2007, Pages 92-103. We define logical relevance as the idea that answers should not be considered as absolutely true or false in relation to a question, but should be considered true more flexibly in a sliding scale of aptness. Then it becomes possible to reason rigorously about the appropriateness of an answer even in cases where the sources of answers are incomplete or inconsistent or contain errors. The authors show how logical relevance can be implemented through the use of measured simplification, a form of constraint relaxation, in order to seek a logical proof than an answer is in fact an answer to a particular question.

**[0330]** Our model of CDT attempts to combine general rhetoric and speech act information in a single structure. While speech acts provide a useful characterization of one kind of pragmatic force, more recent work, especially in building dialogue systems, has significantly expanded this core notion, modeling more kinds of conversational functions that an utterance can play. The resulting enriched acts are called dialogue acts. See Jurafsky, Daniel, & Martin, James H. 2000. *Speech and Language Processing: An Introduction to Natural Language Processing, Computational Linguistics, and Speech Recognition*. Upper Saddle River, N.J.: Prentice Hall. In their multi-level approach to conversation acts Traum and Hinkelman distinguish four levels of dialogue acts necessary to assure both coherence and content of conversation. See Traum, David R. and James F. Allen.

1994. Discourse obligations in dialogue processing. In Proceedings of the 32nd annual meeting on Association for Computational Linguistics (ACL '94). Association for Computational Linguistics, Stroudsburg, Pa., USA, 1-8. The four levels of conversation acts are: turn-taking acts, grounding acts, core speech acts, and argumentation acts.

**[0331]** Research on the logical and philosophical foundations of Q/A has been conducted over a few decades, having focused on limited domains and systems of rather small size and been found to be of limited use in industrial environments. The ideas of logical proof of “being an answer to” developed in linguistics and mathematical logic have been shown to have a limited applicability in actual systems. Most current applied research, which aims to produce working general-purpose (“open-domain”) systems, is based on a relatively simple architecture, combining Information Extraction and Retrieval, as was demonstrated by the systems presented at the standard evaluation framework given by the Text Retrieval Conference (TREC) Q/A track.

**[0332]** (Sperber and Wilson 1986) judged answer relevance depending on the amount of effort needed to “prove” that a particular answer is relevant to a question. This rule can be formulated via rhetoric terms as Relevance Measure: the less hypothetical rhetoric relations are required to prove an answer matches the question, the more relevant that answer is. The effort required could be measured in terms of amount of prior knowledge needed, inferences from the text or assumptions. In order to provide a more manageable measure we propose to simplify the problem by focusing on ways in which constraints, or rhetoric relations, may be removed from how the question is formulated. In other words, we measure how the question may be simplified in order to prove an answer. Resultant rule is formulated as follows: The relevance of an answer is determined by how many rhetoric constraints must be removed from the question for the answer to be proven; the less rhetoric constraints must be removed, the more relevant the answer is.

**[0333]** There is a very limited corpus of research on how discovering rhetoric relations might help in Q/A. Kontos introduced the system which allowed an exploitation of rhetoric relations between a “basic ” text that proposes a model of a biomedical system and parts of the abstracts of papers that present experimental findings supporting this model. See Kontos, John, Joanna Malagardi , John Peros (2016) Question Answering and Rhetoric Analysis of Biomedical Texts in the AROMA System. Unpublished Manuscript.

**[0334]** Adjacency pairs are defined as pairs of utterances that are adjacent, produced by different speakers, ordered as first part and second part, and typed—a particular type of first part requires a particular type of second part. Some of these constraints could be dropped to cover more cases of dependencies between utterances. See Popescu-Belis, Andrei. Dialogue Acts: One or More Dimensions? Tech Report ISSCO Working paper n. 62. 2005.

**[0335]** Adjacency pairs are relational by nature, but they could be reduced to labels (‘first part’, ‘second part’, ‘none’), possibly augmented with a pointer towards the other member of the pair. Frequently encountered observed kinds of adjacency pairs include the following ones: request/offer/invite→accept/refuse; assess→agree/disagree; blame→denial/admission; question→answer; apology→downplay; thank→welcome; greeting→greeting. See Levinson,

Stephen C. 2000. Presumptive Meanings: The Theory of Generalized Conversational Implicature. Cambridge, Mass.: The MIT Press.

**[0336]** Rhetoric relations, similarly to adjacency pairs, are a relational concept, concerning relations between utterances, not utterances in isolation. It is however possible, given that an utterance is a satellite with respect to a nucleus in only one relation, to assign to the utterance the label of the relation. This poses strong demand for a deep analysis of dialogue structure. The number of rhetoric relations in RST ranges from the ‘dominates’ and ‘satisfaction-precedes’ classes used by (Grosz and Sidner 1986) to more than a hundred types. Coherence relations are an alternative way to express rhetoric structure in text. See Scholman, Merel, Jacqueline Evers-Vermeul, Ted Sanders. Categories of coherence relations in discourse annotation. Dialogue & Discourse, Vol 7, No 2 (2016)

**[0337]** There are many classes of NLP applications that are expected to leverage informational structure of text. DT can be very useful is text summarization. Knowledge of salience of text segments, based on nucleus-satellite relations proposed by Sparck-Jones 1995 and the structure of relation between segments should be taken into account to form exact and coherent summaries. See Sparck Jones, K. Summarising: analytic framework, key component, experimental method’, in Summarising Text for Intelligent Communication, (Ed. B. Endres-Niggemeyer, J. Hobbs and K. Sparck Jones), Dagstuhl Seminar Report 79 (1995). One can generate the most informative summary by combining the most important segments of elaboration relations starting at the root node. DTs have been used for multi-document summaries. See Radev, Dragomir R., Hongyan Jing, and Malgorzata Budzikowska. 2000. Centroid-based summarization of multiple documents: sentence extraction, utility-based evaluation, and user studies. In Proceedings of the 2000 NAACL-ANLPWorkshop on Automatic summarization—Volume 4

**[0338]** In the natural language generation problem, whose main difficulty is coherence, informational structure of text can be relied upon to organize the extracted fragments of text in a coherent way. A way to measure text coherence can be used in automated evaluation of essays. Since a DT can capture text coherence, then yielding discourse structures of essays can be used to assess the writing style and quality of essays. Burstein described a semi-automatic way for essay assessment that evaluated text coherence. See Burstein, Jill C., Lisa Braden-Harder, Martin S. Chodorow, Bruce A. Kaplan, Karen Kukich, Chi Lu, Donald A. Rock and Susanne Wolff (2002).

**[0339]** The neural network language model proposed in (engio 2003 uses the concatenation of several preceding word vectors to form the input of a neural network, and tries to predict the next word. See Bengio, Yoshua, Réjean Ducharme, Pascal Vincent, and Christian Janvin. 2003. A neural probabilistic language model. J. Mach. Learn. Res. 3 (March 2003), 1137-1155. The outcome is that after the model is trained, the word vectors are mapped into a vector space such that Distributed Representations of Sentences and Documents semantically similar words have similar vector representations. This kind of model can potentially operate on discourse relations, but it is hard to supply as rich linguistic information as we do for tree kernel learning. There is a corpus of research that extends word2vec models to go beyond word level to achieve phrase-level or sentence-

level representations. For instance, a simple approach is using a weighted average of all the words in the document, (weighted averaging of word vectors), losing the word order similar to how bag-of-words approaches do. A more sophisticated approach is combining the word vectors in an order given by a parse tree of a sentence, using matrix-vector operations. See R. Socher, C. D. Manning, and A. Y. Ng. 2010. Learning continuous phrase representations and syntactic parsing with recursive neural networks. In Proceedings of the NIPS-2010 Deep Learning and Unsupervised Feature Learning Workshop. Using a parse tree to combine word vectors, has been shown to work for only sentences because it relies on parsing.

**[0340]** Many early approaches to policy learning for dialogue systems used small state spaces and action sets, and concentrated on only limited policy learning experiments (for example, type of confirmation, or type of initiative). The Communicator dataset (Walker et al 2001) is the largest available corpus of human-machine dialogues, and has been further annotated with dialogue contexts. This corpus has been extensively used for training and testing dialogue managers, however it is restricted to information requesting dialogues in the air travel domain for a limited number of attributes such as destination city. At the same time, in the current work we relied on the extensive corpus of request-response pairs of various natures.

**[0341]** Reichman 1985 gives a formal description and an ATN (Augmented Transition Network) model of conversational moves, with reference to conventional methods for recognizing the speech act of an utterance. The author uses the analysis of linguistic markers similar to what is now used for rhetoric parsing such as pre-verbal ‘please’, modal auxiliaries, prosody, reference, clue phrases (such as ‘Yes, but . . .’ (sub-argument concession and counter argument), ‘Yes, and . . .’ (argument agreement and further support), ‘No’ and ‘Yes’ (disagreement/agreement), ‘Because . . .’ (support), etc.) and other illocutionary indicators. See Reichman, R. 1985. Getting computers to talk like you and me: discourse context, focus and semantics (an ATN model). Cambridge, Mass. London: MIT Press.

**[0342]** Given a DT for a text as a candidate answer to a compound query, proposed a rule system for valid and invalid occurrence of the query keywords in this DT. See Galisky 2015. To be a valid answer to a query, its keywords need to occur in a chain of elementary discourse units of this answer so that these units are fully ordered and connected by nucleus—satellite relations. An answer might be invalid if the queries’ keywords occur in the answer’s satellite discourse units only.

#### Dialog Games

**[0343]** In an arbitrary conversation, a question is typically followed by an answer, or some explicit statement of an inability or refusal to answer. There is the following model of the intentional space of a conversation. From the yielding of a question by Agent B, Agent A recognizes Agent B’s goal to find out the answer, and it adopts a goal to tell B the answer in order to be co-operative. A then plans to achieve the goal, thereby generating the answer. This provides an elegant account in the simple case, but requires a strong assumption of co-operativeness. Agent A must adopt agent B’s goals as her own. As a result, it does not explain why A says anything when she does not know the answer or when she is not ready to accept B’s goals.

**[0344]** Litman and Allen introduced an intentional analysis at the discourse level in addition to the domain level, and assumed a set of conventional multi-agent actions at the discourse level. See Litman, D. L. and Allen, J. F. 1987. A plan recognition model for subdialogues in conversation, *Cognitive Science*, 11: 163-2. Others have tried to account for this kind of behavior using social intentional constructs such as Joint intentions. See Cohen P. R. & Levesque, H. J. 1990. Intention is choice with commitment, *Artificial Intelligence*, 42: 213-261. See also Grosz, Barbara J., & Sidner, Candace L. 1986. Attentions, Intentions and the Structure of Discourse. *Computational Linguistics*, 12(3), 175-204. While these accounts do help explain some discourse phenomena more satisfactorily, they still require a strong degree of cooperativity to account for dialogue coherence, and do not provide easy explanations of why an agent might act in cases that do not support high-level mutual goals.

**[0345]** Let us imagine a stranger approaching a person and asking, “Do you have spare coins?” It is unlikely that there is a joint intention or shared plan, as they have never met before. From a purely strategic point of view, the agent may have no interest in whether the stranger’s goals are met. Yet, typically agents will still respond in such situations. Hence an account of Q/A must go beyond recognition of speaker intentions. Questions do more than just provide evidence of a speaker’s goals, and something more than adoption of the goals of an interlocutor is involved in formulating a response to a question.

**[0346]** Mann proposed a library of discourse level actions, sometimes called dialogue games, which encode common communicative interactions. See Mann, William and Sandra Thompson. 1988. Rhetorical structure theory: Towards a functional theory of text organization. *Text-Interdisciplinary Journal for the Study of Discourse*, 8(3):243-281. To be co-operative, an agent must always be participating in one of these games. So if a question is asked, only a fixed number of activities, namely those introduced by a question, are co-operative responses. Games provide a better explanation of coherence, but still require the agents to recognize each other’s intentions to perform the dialogue game. As a result, this work can be viewed as a special case of the intentional view. Because of this separation, they do not have to assume co-operation on the tasks each agent is performing, but still require recognition of intention and co-operation at the conversational level. It is left unexplained what goals motivate conversational co-operation.

**[0347]** Coulthard and Brazil suggested that responses can play a dual role of both response and new initiation: Initiation^(Re-Initiation)^Response^(Follow-up). See Coulthard, R. M. and Brazil D. 1979. Exchange structure: Discourse analysis monographs no. 5. Birmingham: The University of Birmingham, English Language Research. Exchanges can consist of two to four utterances. Also, follow-up itself could be followed up. Opening moves indicate the start of the exchange sometimes, which do not restrict the type of the next move. Finally, closing moves sometimes occur which are not necessarily a follow-up. When these observations are added to their formula one ends up with:

**[0348]** (Open)^Initiation^(Re-Initiation)^Response^(Feedback)^Follow-up^(Close)

**[0349]** This now can deal with anything from two to seven more exchanges.

**[0350]** FIG. 26 illustrates discourse acts of a dialogue in accordance with an aspect. Tsui (1994) characterizes the

discourse acts according to a three-part transaction. Her systems of choice for Initiating, Responding and Follow-up are shown in FIG. 26 on the top, middle and bottom correspondingly.

**[0351]** FIG. 27 illustrates discourse acts of a dialogue in accordance with an aspect.

**[0352]** The classification problem of valid vs invalid RR pairs is also applicable to the task of complete dialogue generation beyond question answering and automated dialogue support. Popescu presented a logic-based rhetorical structuring component of a natural language generator for human-computer dialogue. See Popescu, Vladimir, Jean Caelen, Corneliu Burileanu. Logic-Based Rhetorical Structuring for Natural Language Generation in Human-Computer Dialogue. Lecture Notes in Computer Science Volume 4629, pp 309-317, 2007. The pragmatic and contextual aspects are taken into account communicating with a task controller providing domain and application-dependent information, structured in fully formalized task ontology. In order to achieve the goal of computational feasibility and generality, discourse ontology has been built and a number of axioms introducing constraints for rhetoric relations have been proposed.

**[0353]** For example, the axiom specifying the semantics of  $\text{topic}(\alpha)$  is given below:

**[0354]**  $\text{topic}(\alpha) ::= \text{ExhaustiveDecomposition}(i, j; v_i, \omega_j) \ \& \ \text{memberOf}(v_i, K(\alpha)) \ \& \ \text{memberOf}(\omega_j, \Omega) (\exists k: \text{equals}(vk, \omega_j) \ \& \ \text{memberOf}(vk, K(\alpha)))$ .

where  $K(\alpha)$  the clause logically expressing the semantics of the utterance  $\alpha$ .

**[0355]** The notion of topic of an utterance is defined here in terms of sets of objects in the domain ontology, referred to in a determined manner in the utterance. Hence, the topic relations between utterances are computed using the task/domain ontology, handled by the task controller.

**[0356]** As an instance of such rule one can consider

**[0357]**  $\text{topic}(\beta) ::= \text{ExhaustiveDecomposition}(\text{book}, \text{read}, \text{good time}('14 \text{ h}'), \text{good time}('monday'), \text{t+})$ ;

**[0358]**  $-\text{good time}(\theta) ::= \exists \gamma, \pi: \neg \text{Disjoint}(\text{topic}(\gamma), \text{topic}(\pi)) \ \& \ \text{smaller}(\text{t}\alpha, \text{t}\pi) \ \& \ ((\text{SubclassOf}(\theta, \Delta\text{t}\alpha) \vee \text{equals}(\theta, \Delta\text{t}\alpha)) \ \& \ \pi: \text{equals}(\Delta\text{t}\pi, \theta))$ ;

**[0359]** where  $\text{t+}$  is “future and ‘new’”.

#### Rhetoric Relations and Argumentation

**[0360]** Frequently, the main means of linking questions and answers is logical argumentation. There is an obvious connection between RST and argumentation relations which tried to learn in this study. There are four types of relations: the directed relations support, attack, detail, and the undirected sequence relation. The support and attack relations are argumentative relations, which are known from related work. See Peldszus, A. and Stede, M. 2013. From Argument Diagrams to Argumentation Mining in Texts: A Survey. *Int. J. of Cognitive Informatics and Natural Intelligence* 7(1), 1-31. The latter two correspond to discourse relations used in RST. The argumentation sequence relation corresponds to “Sequence” in RST, the argumentation detail relation roughly corresponds to “Background” and “Elaboration”.

**[0361]** Argumentation detail relation is important because many cases in scientific publications, where some background information (for example the definition of a term) is important for understanding the overall argumentation. A support relation between an argument component Resp and another argument component Req indicates that Resp sup-

ports (reasons, proves) Req. Similarly, an attack relation between Resp and Req is annotated if Resp attacks (restricts, contradicts) Req. The detail relation is used, if Resp is a detail of Req and gives more information or defines something stated in Req without argumentative reasoning. Finally, we link two argument components (within Req or Resp) with the sequence relation, if the components belong together and only make sense in combination, i.e., they form a multi-sentence argument component.

**[0362]** We observed that using SVM TK one can differentiate between a broad range of text styles (Galitsky 2015), including ones without argumentation and ones with various forms of argumentation. Each text style and genre has its inherent rhetoric structure which is leveraged and automatically learned. Since the correlation between text style and text vocabulary is rather low, traditional classification approaches which only take into account keyword statistics information could lack the accuracy in the complex cases. We also performed text classification into rather abstract classes such as the belonging to language-object and meta-language in literature domain and style-based document classification into proprietary design documents. See Galitsky, B, Ilvovsky, D. and Kuznetsov S O. Rhetoric Map of an Answer to Compound Queries Knowledge Trail Inc. *ACL 2015*, 681-686 Evaluation of text integrity in the domain of valid vs invalid customer complains (those with argumentation flow, non-cohesive, indicating a bad mood of a complainant) shows the stronger contribution of rhetoric structure information in comparison with the sentiment profile information. Discourse structures obtained by RST parser are sufficient to conduct the text integrity assessment, whereas sentiment profile-based approach shows much weaker results and also does not complement strongly the rhetoric structure ones.

**[0363]** An extensive corpus of studies has been devoted to RST parsers, but the research on how to leverage RST parsing results for practical NLP problems is limited to content generation, summarization and search (Jansen et al 2014). DTs obtained by these parsers cannot be used directly in a rule-based manner to filter or construct texts. Therefore, learning is required to leverage implicit properties of DTs. This study is a pioneering one, to the best of our knowledge, that employs discourse trees and their extensions for general and open-domain question answering, chatbots, dialogue management and text construction.

**[0364]** Dialogue chatbot systems need to be capable of understanding and matching user communicative intentions, reason with these intentions, build their own respective communication intentions and populate these intentions with actual language to be communicated to the user. Discourse trees on their own do not provide representation for these communicative intents. In this study we introduced the communicative discourse trees, built upon the traditional discourse trees, which can be massively produced nowadays on one hand and constitute a descriptive utterance-level model of a dialogue on the other hand. Handling dialogues via machine learning of communicative discourse trees allowed us to model a wide array of dialogue types of collaboration modes and interaction types (planning, execution, and interleaved planning and execution).

**[0365]** Statistical computational learning approaches offer several key potential advantages over the manual rule-based hand-coding approach to dialogue systems development:

[0366] data-driven development cycle;  
 [0367] provably optimal action policies;  
 [0368] a more accurate model for the selection of responses;  
 [0369] possibilities for generalization to unseen states;  
 [0370] reduced development and deployment costs for industry.

[0371] Comparing inductive learning results with the kernel-based statistical learning, relying on the same information allowed us to perform more concise feature engineering than either approach would do.

[0372] An extensive corpus of literature on RST parsers does not address the issue of how the resultant DT will be employed in practical NLP systems. RST parsers are mostly evaluated with respect to agreement with the test set annotated by humans rather than its expressiveness of the features of interest. In this work we focus on interpretation of DT and explored ways to represent them in a form indicative of an agreement or disagreement rather than neutral enumeration of facts.

[0373] To provide a measure of agreement for how a given message in a dialogue is followed by a next message, we used CDIs, which now include labels for communicative actions in the form of substituted VerbNet frames. We investigated the discourse features that are indicative of correct vs incorrect request-response and question-answer pairs. We used two learning frameworks to recognize correct pairs: deterministic, nearest-neighbor learning of CDTs as graphs, and a tree kernel learning of CDTs, where a feature space of all CDI sub-trees is subject to SVM learning.

[0374] The positive training set was constructed from the correct pairs obtained from Yahoo Answers, social network, corporate conversations including Enron emails, customer complaints and interviews by journalists. The corresponding negative training set was created by attaching responses for different, random requests and questions that included relevant keywords so that relevance similarity between requests and responses are high. The evaluation showed that it is possible to recognize valid pairs in 68-79% of cases in the domains of weak request-response agreement and 80-82% of cases in the domains of strong agreement. These accuracies are essential to support automated conversations. These accuracies are comparable with the benchmark task of classification of discourse trees themselves as valid or invalid, and also with factoid question-answering systems.

[0375] We believe this study is the first one that leverages automatically built discourse trees for question answering support. Previous studies used specific, customer discourse models and features which are hard to systematically collect, learn with explainability, reverse engineer and compare with each other. We conclude that learning rhetoric structures in the form of CDTs are key source of data to support answering complex questions, chatbots and dialogue management. Argumentation Detection using Communicative Discourse Trees

[0376] Aspects described herein use communicative discourse trees to determine whether a text contains argumentation. Such an approach can be useful, for example, for chatbots to be able to determine whether a user is arguing or not. When a user attempts to provide an argument for something, a number of argumentation patterns can be employed. An argument can be a key point of any communication, persuasive essay, or speech.

[0377] A communicative discourse tree for a given text reflects the argumentation present in the text. For example, the basic points of argumentation are reflected in the rhetoric structure of text where an argument is presented. A text without argument has different rhetoric structures. See Moens, Marie-Francine, Erik Boiy, Raquel Mochales Palau, and Chris Reed. 2007. Automatic detection of arguments in legal texts. In Proceedings of the 11th International Conference on Artificial Intelligence and Law, ICAIL '07, pages 225-230, Stanford, Calif., USA.) Additionally, argumentation can differ between domains. For example, for product recommendation, texts with positive sentiments are used to encourage a potential buyer to make a purchase. In the political domain, the logical structure of sentiment versus argument versus agency is much more complex.

[0378] Machine learning can be used in conjunction with communicative discourse trees to determine argumentation. Determining argumentation can be tackled as a binary classification task in which a communicative discourse tree that represents a particular block of text is provided to a classification model. The classification model returns a prediction of whether the communicative discourse tree is in a positive class or a negative class. The positive class corresponds to texts with arguments and the negative class corresponds to texts without arguments. Aspects described herein can perform classification based on different syntactic and discourse features associated with logical argumentation. In an example, for a text to be classified as one containing an argument, the text is similar to the elements of the first class to be assigned to this class. To evaluate the contribution of our sources, two types of learning can be used: nearest neighbor and statistical learning approaches.

[0379] Nearest Neighbor (kNN) learning uses explicit engineering of graph descriptions. The similarity measured is the overlap between the graph of a given text and that of a given element of training set. In statistical learning, aspects learn structures with implicit features.

[0380] Generally, the machine learning approaches estimate the contribution of each feature type and the above learning methods to the problem of argument identification including the presence of opposing arguments (Stab and Gurevych, 2016). More specifically, aspects use the rhetoric relations and how the discourse and semantic relations work together in an argumentation detection task.

[0381] Whereas sentiment analysis is necessary for a broad range of industrial applications, its accuracy remains fairly low. Recognition of a presence of an argument, if done reliably, can potentially substitute some opinion mining tasks when one intends to differentiate a strong opinionated content from the neutral one. Argument recognition result can then serve as a feature of sentiment analysis classifier, differentiating cases with high sentiment polarity from the neutral ones, ones with low polarity.

Example of Using Communicative Discourse Trees to Analyse Argumentation

[0382] The following examples are introduced to illustrate the value of using communicative discourse trees to determine the presence of argumentation in text. The first example discusses Theranos, a healthcare company that hoped to make a revolution in blood tests. Some sources, including the Wall Street Journal, claimed that the company's conduct was fraudulent. The claims were made based on the whistleblowing of employees who left Theranos. At



some point FDA got involved. In 2016, some of the public believed Theranos' position, that the case was initiated by Theranos competitors who felt jealous about the efficiency of blood test technique promised by Theranos. However, using argumentation analysis, aspects described herein illustrate that the Theranos argumentation patterns mined at their website were faulty. In fact, a fraud case was pushed forward, which led to the massive fraud verdict. According to the Securities and Exchange Commission, Theranos CEO Elizabeth Holmes raised more than \$700 million from investors "through an elaborate, years-long fraud" in which she exaggerated or made false statements about the company's technology and finances.

[0383] Considering the content about Theranos, if a user leans towards Theranos and not its opponents, then an argumentation detection system attempts to provide answers favoring Theranos position. Good arguments of its proponents, or bad arguments of its opponents would also be useful in this case. Table 4 shows the flags for various combinations of agency, sentiments and argumentation for tailoring search results for a given user with certain preferences of entity A vs entity B. The right grayed side of column has opposite flags for the second and third row. For the fourth row, only the cases with generally accepted opinion sharing merits are flagged for showing.

[0384] A chatbot can use the information in Table 4 to personalize responses or tailor search results or opinionated data to user expectations. For example, a chatbot can consider political viewpoint when providing news to a user. Additionally, personalizing responses is useful for product recommendations. For example, a particular user might prefer skis over snowboards as evidenced by a user's sharing of stories of people who do not like snowboarders. In this manner, the aspects described herein enable a chatbot can behave like a companion, by showing empathy and ensuring that the user does not feel irritated by the lack of common ground with the chatbot.

Wall Street Journal has published a series of anonymously sourced accusations that inaccurately portray Theranos. Now, in its latest story ("U.S. Probes Theranos Complaints," December 20), the Journal once again is relying on anonymous sources, this time reporting two undisclosed and unconfirmed complaints that allegedly were filed with the Centers for Medicare and Medicaid Services (CMS) and U.S. Food and Drug Administration (FDA)." (Carreyrou, 2016)

[0386] FIG. 28 depicts an exemplary communicative discourse tree in accordance with an aspect. FIG. 28 depicts discourse tree 2800, communicative action 2801 and communicative action 2802. More specifically, discourse tree 2800 represents the following paragraph: "But Theranos has struggled behind the scenes to turn the excitement over its technology into reality. At the end of 2014, the lab instrument developed as the linchpin of its strategy handled just a small fraction of the tests then sold to consumers, according to four former employees." As can be seen, when arbitrary communicative actions are attached to the discourse tree 2800 as labels of terminal arcs, it becomes clear that the author is trying to bring her point across and not merely sharing a fact. As shown, communicative action 2801 is a "struggle" and communicative action 2802 is "develop."

[0387] FIG. 29 depicts an exemplary communicative discourse tree in accordance with an aspect. FIG. 29 depicts discourse tree 2900, which represents the following text: "Theranos remains actively engaged with its regulators, including CMS and the FDA, and no one, including the Wall Street Journal, has provided Theranos a copy of the alleged complaints to those agencies. Because Theranos has not seen these alleged complaints, it has no basis on which to evaluate the purported complaints." But as can be seen, from only the discourse tree and multiple rhetoric relations of elaboration and a single instance of background, it is unclear whether an author argues with his opponents or enumerates some observations. Relying on communicative actions such

TABLE 4

Answer type	Request from user					
	Positive sentiment for A	Negative sentiment for B	Proper argumentation that A is right	Improper argumentation that A is wrong	Proper argumentation by a proponent of A	Improper argumentation by a opponent of A
Favoring A rather than B	+	+	+	+	+	-
Favoring B rather than A						+
Equal treatment of A and B	+		+		+	

[0385] Continuing the Theranos example, a RST representation of the arguments is constructed and aspects can observe if a discourse tree is capable of indicating whether a paragraph communicates both a claim and an argumentation that backs it up. Additional information is added to a discourse tree such that it is possible to judge if it expresses an argumentation pattern or not. According to the Wall Street Journal, this is what happened : "Since October [2015], the

as "engaged" or "not see", CDT can express the fact that the author is actually arguing with his opponents

[0388] FIG. 30 depicts an exemplary communicative discourse tree in accordance with an aspect. FIG. 30 depicts discourse tree 3000, which represents the following text, in which Theranos is attempting to get itself off the hook: "It is not unusual for disgruntled and terminated employees in the heavily regulated health care industry to file complaints

in an effort to retaliate against employers for termination of employment. Regulatory agencies have a process for evaluating complaints, many of which are not substantiated. Theranos trusts its regulators to properly investigate any complaints.”

**[0389]** As can be seen, to show the structure of arguments, discourse relations are necessary but insufficient, and speech acts (communicative actions) are necessary but insufficient as well. For the paragraph associated with FIG. 30, it is necessary to know the discourse structure of interactions between agents, and what kind of interactions they are. More specifically, differentiation is needed between a neutral elaboration (which does not include a communicative action) and an elaboration relation which includes a communicative action with a sentiment such as “not provide” which is correlated with an argument. Note that the domain of interaction (e.g., healthcare) is not necessary, nor are the subjects of these interactions (the company, the journal, the agencies), or what the entities are. However, mental, domain-independent relations between these entities are useful.

**[0390]** FIG. 31 depicts an exemplary communicative discourse tree in accordance with an aspect. FIG. 31 depicts discourse tree 3100, which represents the following text for Theranos’ argument that the opponent’s arguments are faulty: “By continually relying on mostly anonymous sources, while dismissing concrete facts, documents, and expert scientists and engineers in the field provided by Theranos, the Journal denies its readers the ability to scrutinize and weigh the sources’ identities, motives, and the veracity of their statements.”

**[0391]** From the commonsense reasoning standpoint, Theranos, the company, has two choices to confirm the argument that its tests are valid: (1) conduct independent investigation, comparing their results with the peers, opening the data to the public, confirming that their analysis results are correct; and (2) defeat the argument by its opponent that their testing results are invalid, and providing support for the claim that their opponent is wrong. Obviously, the former argument is much stronger and usually the latter argument is chosen when the agent believes that the former argument is too hard to implement. On one hand, the reader might agree with Theranos that WSJ should have provided more evidence for its accusations against the company. On the other hand, the reader perhaps disliked the fact that Theranos selects the latter argument type (2) above, and therefore the company’s position is fairly weak. One reason that that Theranos’ argument is weak is because the company tries to refute the opponent’s allegation concerning the complaints about Theranos’s services from clients. Theranos’ demand for evidence by inviting WSJ to disclose the sources and the nature of the complaints is weak. A claim is that a third-party (independent investigative agent) would be more reasonable and conclusive. However, some readers might believe that the company’s argument (burden of proof evasion) is logical and valid. Note that an argumentation assessor cannot identify the rhetorical relations in a text by relying on text only. Rather, the context of the situation is helpful in order to grasp the arguer’s intention.

**[0392]** In a second example, an objective of the author is to attack a claim that the Syrian government used chemical weapon in the spring of 2018. FIG. 32 depicts an example

communicative discourse tree in accordance with an aspect. FIG. 32 depicts communicative discourse tree 3200 for this second example.

**[0393]** Considering the example, an acceptable proof would be to share a certain observation, associated from the standpoint of peers, with the absence of a chemical attack. For example, if it is possible to demonstrate that the time of the alleged chemical attack coincided with the time of a very strong rain, that would be a convincing way to attack this claim. However, since no such observation was identified, the source, Russia Today, resorted to plotting a complex mental states concerning how the claim was communicated, where it is hard to verify most statements about the mental states of involved parties. The following shows the elementary discourse units split by the discourse parser: [Whatever the Douma residents ,][who had first-hand experience of the shooting of the water] [dousing after chemical attack video ,][have to say ,][their words simply do not fit into the narrative] [allowed in the West .] [analysts told RT .] [Footage of screaming bewildered civilians and children] [being doused with water ,][presumably to decontaminate them ,][was a key part in convincing Western audiences] [that a chemical attack happened in Douma .] [Russia brought the people][seen in the video][to Brussels ,][where they told anyone] [interested in listening] [that the scene was staged .] [Their testimonies , however , were swiftly branded as bizarre and underwhelming and even an obscene masquerade] [staged by Russians .] [They refuse to see this as evidence ,][obviously pending][what the OPCW team is going to come up with in Douma ], [Middle East expert Ammar Waqqaf said in an interview with RT .] [The alleged chemical incident ,][without any investigation , has already become a solid fact in the West ,][which the US , Britain and France based their retaliatory strike on .]

**[0394]** Note that the text above does not find counter-evidence for the claim of the chemical attack it attempts to defeat. Instead, the text states that the opponents are not interested in observing this counter-evidence. The main statement of this article is that a certain agent “disallows” a particular kind of evidence attacking the main claim, rather than providing and backing up this evidence. Instead of defeating a chemical attack claim, the article builds a complex mental states conflict between the residents, Russian agents taking them to Brussels, the West and a Middle East expert.

**[0395]** FIG. 33 depicts an example communicative discourse tree in accordance with an aspect. FIG. 33 depicts communicative discourse tree 3300 for another controversial story, a Trump-Russia link acquisition (BBC 2018). For a long time, the BBC was unable to confirm the claim, so the story is repeated and over and over again to maintain a reader expectation that it would be instantiated one day. There is neither confirmation nor rejection that the dossier exists, and the goal of the author is to make the audience believe that such dossier exists without misrepresenting events. To achieve this goal, the author can attach a number of hypothetical statements about the existing dossier to a variety of mental states to impress the reader in the authenticity and validity of the topic.

**[0396]** As depicted in FIGS. 32 and 33, many rhetorical relations are associated with mental states. Mental states are sufficiently complex that it is hard for a human to verify a correctness of the main claim. The communicative discourse tree shows that an author is attempting to substitute a logical

chain which would back up a claim with complex mental states. By simply looking at the CDTs depicted in FIGS. 32 and 33 without reading the associated text sufficient to see that the line of argument is faulty.

#### Handling Heated Arguments

[0397] FIG. 34 depicts an example communicative discourse tree in accordance with an aspect. FIG. 34 depicts communicative discourse tree 3400 for an example of a heated argumentation. Specifically, the following text, represented by communicative discourse tree 3400 illustrates an example of a CDT for a heated argumentation of a customer treated badly by a credit card company American Express (Amex) in 2007. The communicative discourse tree 3400 shows a sentiment profile. A sentiment profile is a sentiment value attached to an indication of a proponent (in this case, “me”) and an opponent (in this case, “Amex”). As can be seen, the proponent is almost always positive and the opponent is negative confirms the argumentation flow of this complaint. Oscillating sentiment values would indicate that there is an issue with how an author provides argumentation.

[0398] The text is split into logical chunks is as follows: [I’m another one of the many] [that has been carelessly mistreated by American Express .] [I have had my card since 2004 and never late .] [In 2008][they reduced my credit limit from \$16,600 to \$6,000][citing several false excuses .] [Only one of their excuses was true—other credit card balances .] [They also increased my interest rate by 3%][at the same time .] [I have never been so insulted by a credit card company .] [I used to have a credit score of 830 , not anymore , thanks to their unfair credit practices .] [They screwed my credit score .] [In these bad economic times you’d think] [they would appreciate consistent paying customers like us] [but I guess] [they are just so full of themselves .] [I just read today][that their CEO stated][that they will be hurt less than their competitors] [because 80 percent of their revenues] [are generated from fees. That] [explains their callous , arrogant , unacceptable credit practices .] [It seems] [they have to screw every cardholder] [they can before the new law becomes effective .] [Well America , let’s learn from our appalling experience][and stop using our American Express credit card][so we can pay it off !].

[0399] FIG. 35 depicts an example communicative discourse tree in accordance with an aspect. FIG. 35 depicts communicative discourse tree 3500 that represents a text advising on how to behave communicating an argument: “When a person is in the middle of an argument, it can be easy to get caught up in the heat of the moment and say something that makes the situation even worse. Nothing can make someone more frenzied and hysterical than telling them to calm down. It causes the other person to feel as if one is putting the blame for the elevation of the situation on them. Rather than actually helping them calm down, it comes off as patronizing and will most likely make them even angrier.” FIG. 35 is an example of meta-argumentation. A meta-argumentation is an argumentation on how to conduct heated argumentation, which can be expressed by the same rhetorical relations.

#### Using a Machine Learning Model to Determine Argumentation

[0400] As discussed, rhetoric classification application 102 can detect argumentation in text. FIG. 36 depicts an

exemplary process for using machine learning to determine argumentation in accordance with an aspect.

[0401] At block 3601, process 3600 involves accessing text comprising fragments. Rhetoric classification application 102 can text from different sources such input text 130, or Internet-based sources such as chat, Twitter, etc. Text can consist of fragments, sentences, paragraphs, or longer amounts.

[0402] At block 3602, process 3600 involves creating a discourse tree from the text, the discourse tree including nodes and each nonterminal node representing a rhetorical relationship between two of the fragments and each terminal node of the nodes of the discourse tree is associated with one of the fragments. Rhetoric classification application 102 creates discourse in a substantially similar manner as described in block 1502 in process 1500.

[0403] At block 3603, process 3600 involves matching each fragment that has a verb to a verb signature, thereby creating a communicative discourse tree. Rhetoric classification application 102 creates discourse in a substantially similar manner as described in steps 1503-1505 in process 1500.

[0404] At block 3604, process 3600 involves determining whether the communicative discourse tree includes argumentation by applying a classification model trained to detect argumentation to the communicative discourse tree. The classification model can use different learning approaches. For example, the classification model can use a support vector machine with tree kernel learning. Additionally, the classification model can use nearest neighbor learning of maximal common sub-trees.

[0405] As an example, rhetoric classification application 102 can use machine learning to determine similarities between the communicative discourse tree identified at block 3603 and one or more communicative discourse trees from a training set of communicative discourse trees. Rhetoric classification application 102 can select an additional communicative discourse tree from a training set that includes multiple communicative discourse trees. Training can be based on the communicative discourse tree having a highest number of similarities with the additional communicative discourse tree. Rhetoric classification application 102 identifies whether the additional communicative discourse tree is from a positive set or a negative set. The positive set is associated with text containing argumentation and the negative set is associated with text containing no argumentation. Rhetoric classification application 102 determines based on this identification whether the text contains an argumentation or no argumentation.

#### Evaluation of Logical Argument Detection

[0406] To evaluate argumentation detection, a positive dataset is created from a few sources to make it non-uniform and pick together different styles, genres and argumentation types. First we used a portion of data where argumentation is frequent, e.g. opinionated data from newspapers such as The New York Times (1400 articles), The Boston Globe (1150 articles), Los Angeles Times (2140) and others (1200). Textual customer complaints are also used. Additionally, the text style & genre recognition dataset is used (Lee, 2001). This dataset has a specific dimension associated with argumentation (the section [ted] “Emotional speech on a political topic with an attempt to sound convincing”). And we finally add some texts from standard argument mining datasets

where presence of arguments is established by annotators: “Fact and Feeling” dataset (Oraby et al., 2015), 680 articles and dataset “Argument annotated essays v.2” (Stab and Gurevych, 2016), 430 articles.

[0407] For the negative dataset, Wikipedia (3500 articles), factual news sources (Reuters feed with 3400 articles, and also (Lee, 2001) dataset including such sections of the corpus as [tells] (450 articles), “Instructions for how to use software” (320 articles); [tele], “Instructions for how to use hardware”(175 articles); [news], “A presentation of a news article in an objective, independent manner”(220 articles), and other mixed datasets without argumentation (735 articles) can be used.

[0408] Both positive and negative datasets include 8800 texts. An average text size was 400 words (always above 200 and below 1000 words). We used Amazon Mechanical Turk to confirm that the positive dataset includes argumentation in a commonsense view, according to the employed workers. Twelve workers who had the previous acceptance score of above 85% were assigned the task to label. For manual confirmation of the presence and absence of arguments, we randomly selected representative from each set (about 10%) and made sure they properly belong to a class with above 95% confidence. We avoided sources where such confidence was below 95%. For first portion of texts which were subject to manual labeling we conducted an assessment of inter-annotator agreement and observed that it exceeded 90%. Therefore for the rest of annotations we relied on a single worker per text. For the evaluation we split out dataset into the training and test part in proportion of 4:1.

#### Specific Argumentation Pattern Dataset

[0409] The purpose of this argumentation dataset is to collect textual complaints where the authors use a variety of argumentation means to prove that they are victims of businesses. Customer complainants are emotionally charged texts which include descriptions of problems they experienced with certain businesses. Raw complaints are collected from PlanetFeedback.com for a number of banks submitted in years 2006-2010. Four hundred complaints are manually tagged with respect to the following parameters related to argumentation:

- [0410] perceived complaint validity,
- [0411] argumentation validity
- [0412] presence of specific argumentation patter
- [0413] and detectable misrepresentation.

[0414] Judging by complaints, most complainants are in genuine distress due to a strong deviation between what they expected from a service, what they received and how it was communicated. Most complaint authors report incompetence, flawed policies, ignorance, indifference to customer needs and misrepresentation from the customer service personnel.

[0415] The authors are frequently exhausted communicative means available to them, confused, seeking recommendation from other users and advise others on avoiding particular financial service. The focus of a complaint is a proof that the proponent is right and her opponent is wrong, resolution proposal and a desired outcome.

[0416] Multiple argumentation patterns are used in complaints:

[0417] The most frequent is a deviation from what has happened from what was expected, according to common sense. This pattern covers both valid and invalid argumentation (a valid pattern).

[0418] The second in popularity argumentation patterns cites the difference between what has been promised (advertised, communicated) and what has been received or actually occurred. This pattern also mentions that the opponent does not play by the rules (valid).

[0419] A high number of complaints are explicitly saying that bank representatives are lying. Lying includes inconsistencies between the information provided by different bank agents, factual misrepresentation and careless promises (valid).

[0420] Another reason complaints arise is due to rudeness of bank agents and customer service personnel. Customers cite rudeness in both cases, when the opponent point is valid or not (and complaint and argumentation validity is tagged accordingly). Even if there is neither financial loss nor inconvenience the complainants disagree with everything a given bank does, if they been served rudely (invalid pattern).

[0421] Complainants cite their needs as reasons bank should behave in certain ways. A popular argument is that since the government via taxpayers bailed out the banks, they should now favor the customers (invalid).

[0422] This dataset includes more emotionally-heated complaints in comparison with other argument mining datasets. For a given topic such as insufficient funds fee, this dataset provides many distinct ways of argumentation that this fee is unfair. Therefore, our dataset allows for systematic exploration of the topic-independent clusters of argumentation patterns and observe a link between argumentation type and overall complaint validity. Other argumentation datasets including legal arguments, student essays (Stab and Gurevych 2017), internet argument corpus (Abbot et al., 2016), fact-feeling dataset (Oraby et al., 2016) and political debates have a strong variation of topics so that it is harder to track a spectrum of possible argumentation patterns per topic. Unlike professional writing in legal and political domains, authentic writing of complaining users have a simple motivational structure, a transparency of their purpose and occurs in a fixed domain and context. In the dataset used in this study, the arguments play a critical rule for the well-being of the authors, subject to an unfair charge of a large amount of money or eviction from home. Therefore, the authors attempt to provide as strong argumentation as possible to back up their claims and strengthen their case.

[0423] If a complaint is not truthful it is usually invalid: either a customer complains out of a bad mood or she wants to get a compensation. However, if the complaint is truthful it can easily be invalid, especially when arguments are flawed. When an untruthful complaint has valid argumentation patterns, it is hard for an annotator to properly assign it as valid or invalid. Three annotators worked with this dataset, and inter-annotator agreement exceeds 80%.

## Evaluation Setup and Results

**[0424]** For the Nearest Neighbor classification, we used Maximal common sub-graph for DT approach as well as Maximal common sub-graph for CA approach based on scenario graphs built on CAs extracted from text (Table 5). For SVM TK classification, we employed the tree kernel learning of parse thickets approach, where each paragraph is represented by a parse thicket that includes exhaustive syntactic and discourse information. We also used SVM TK for DT, where CA information is not taken into account.

**[0425]** Our family of pre-baseline approaches are based on keywords and keywords statistics. For Naïve Bayes approach, we relied on WEKA framework (Hall et al., 2009). Since mostly lexical and length-based features are reliable for finding poorly-supported arguments (Stab and Gurevych 2017), we used non-NERs as features together with the number of tokens in the phrase which potentially expresses argumentation. Also, NER counts was used as it is assumed to be correlated with the strength of an argument. Even if these features are strongly correlated with arguments, they do not help to understand the nature of how argumentation is structure and communicated in language, as expressed by CDTs.

TABLE 5

Evaluation results. Nearest Neighbor—based detection				
Method & Source	Precision	Recall	F1	Improvement over the baseline
Keywords	57.2	53.1	55.07	0.87
Naïve Bayes	59.4	55.0	57.12	0.91
DT	65.6	60.4	62.89	1.00
CA	62.3	59.5	60.87	0.97
CDT (DT + CA)	83.1	75.8	79.28	1.26

TABLE 6

Evaluation results. SVM TK—based detection				
Method & Source	Precision	Recall	F1	Improvement over the baseline
RST and CA (full parse trees)	77.2	74.4	75.77	1.00
DT	63.6	62.8	63.20	0.83
CDT	82.4	77.0	79.61	1.05

**[0426]** A naïve approach is just relying on keywords to figure out a presence of argumentation. Usually, a couple of communicative actions so that at least one has a negative sentiment polarity (related to an opponent) are sufficient to deduce that logical argumentation is present. This naïve approach is outperformed by the top performing CDT approach by 29%. A Naïve Bayes classifier delivers just 2% improvement.

**[0427]** One can observe that for nearest neighbor learning DT and CA indeed complement each other, delivering accuracy of the CDT 26% above the former and 30% above the latter. Just CA delivered worse results than the stand-alone DT (Table 6). As can be seen, SVM TK of CDT outperforms SVM TK for RST+CA and full syntactic fea-

tures (the SVM TK baseline) by 5%. This is due to feature engineering and relying on less data but more relevant one that the baseline.

TABLE 7

Evaluation results for each positive dataset versus combined negative dataset (SVM TK)				
Method & Source	Newspaper opinionated data, F1	Textual Complaints, F1	Text style & genre recognition dataset, F1	Fact and Feeling
Keywords	52.3	55.2	53.7	54.8
Naïve Bayes	57.1	58.3	57.2	59.4
DT	66.0	63.6	67.9	66.3
CA	64.5	60.3	62.5	60.9
CDT (DT + CA)	77.1	78.8	80.3	79.2

**[0428]** Nearest neighbor learning for CDT achieves slightly lower accuracy than SVM TK for CDT, but the former gives interesting examples of sub-trees which are typical for argumentation, and the ones which are shared among the factual data. The number of the former groups of CDT sub-trees is naturally significantly higher. Unfortunately SVM TK approach does not help to explain how exactly the argument identification problem is solved. It only gives final scoring and class labels. It is possible, but infrequent to express a logical argument without CAs. This observation is backed up by our data.

**[0429]** It is worth mentioning that our evaluation settings are close to SVM-based ranking of RST parses. This problem is formulated as classification of DTs into the set of correct trees, close to manually annotated trees, and incorrect ones. Our settings are a bit different because they are better adjusted to smaller datasets. Notice that argument detection improvement proceeding from DT to CDT demonstrates the adequateness of our extension of RST by speech act—related information.

**[0430]** Table 7 shows the SVM TK argument detection results per source. As a positive set, we now take individual source only. The negative set is formed from the same sources but reduced in size to match the size of a smaller positive set. The cross-validation settings are analogous to our assessment of the whole positive set.

**[0431]** We did not find correlation between the peculiarities of a particular domain and contribution of discourse-level information to argument detection accuracy. At the same time, all these four domains show monotonic improvement when we proceed from Keywords and Naïve Bayes to SVM TK. Since all four sources demonstrate the improvement of argument detection rate due to CDT, we conclude that the same is likely for other source of argumentation-related information.

TABLE 8

Evaluation results for each positive dataset versus combined negative dataset (SVM TK)				
Method & Source	Deviation from what has happened from what was expected	The difference between what has been promised (advertised, communicated) and what has been received or actually occurred	Saying that bank representatives are lying	Rudeness of bank agents and customer service personnel
Keywords	51.7	53.7	58.5	59.0
Naïve Bayes	53.4	55.9	61.3	65.8
DT	61.9	58.5	68.5	68.6
CA	58.8	59.4	63.4	61.6
CDT (DT + CA)	70.3	68.4	84.7	83.0

**[0432]** Pattern—specific argumentation detection results are shown in Table 8. We compute the accuracy of classification as a specific pattern vs other patterns and a lack of argumentation. The first and second type of argument is harder to recognize (by 7-10% below the general argument) and the third and fourth type is easier to detect (exceeds the general argument accuracy by 3%).

**[0433]** These argument recognition accuracies are comparable with state-of-the-art of argumentation mining techniques. One study conducted an analysis of texts containing 128 premise conclusion pairs and obtained 63-67% F-measure, determining the directionality of inferential connections in argumentation. See Lawrence, John and Chris Reed. Mining Argumentative Structure from Natural Language text using Automatically Generated Premise-Conclusion Topic Models. Proceedings of the 4th Workshop on Argument Mining, pages 39-48. 2017. Bar-Haim et al. show that both accuracy and coverage of argument stance recognition (what is supporting and what is defeating a claim) can be significantly improved to 69% F-measure through automatic expansion of the initial lexicon. See Bar-Haim, Roy Lilach Edelstein, Charles Jochim and Noam Slonim. Improving Claim Stance Classification with Lexical Knowledge Expansion and Context Utilization. Proceedings of the 4th Workshop on Argument Mining, pages 32-38. 2017. Aker et al. offer a comparative analysis of the performance of different supervised machine learning methods and feature sets on argument mining tasks, achieving 81% F-measure for detecting argumentative sentences and 59% for argument structure prediction task. See Aker, Ahmet, Alfred Sliwa, Yuan Ma, Ruishen Liu Niravkumar Borad, Seyedeh Fatemeh Ziyaei, Mina Ghbadi What works and what does not: Classifier and feature analysis for argument mining. Proceedings of the 4th Workshop on Argument Mining, pages 91-96. 2017. As to the argumentation segmentation of an argument text into argument units and their non-argumentative counterparts, Ajj our et al achieve 88% using Bi-LSTM for essays and 84% for editorials. See Ajour, Yamen, Wei-Fan Chen, Johannes Kiesel, Henning Wachsmuth and Benno Stein. Unit Segmentation of Argumentative Texts. Proceedings of the 4th Workshop on Argument Mining, pages 118-128, 2017. Taking into account complexities of argument mining tasks, these classification accuracies are comparable with the current study but lack an exploration of causation of argumentation via discourse-level analysis.

Hence this study proposes much more straight-forward feature engineering of general argumentation and its specific patterns.

#### CDT Construction

**[0434]** Although splitting into EDUs works reasonably well, assignment of RST relation is noisy and in some domain its accuracy can be as low as 50%. However, when the RST relation label is random, it does not significantly drop the performance of our argumentation detection system since a random discourse tree will be less similar to elements of positive or negative training set, and most likely will not participate in positive or negative decision. To overcome the noisy input problem, more extensive training datasets are required so that the number of reliable, plausible discourse tree is high enough to cover cases to be classified. As long as this number is high enough, a contribution of noisy, improperly built discourse trees is low.

**[0435]** There is a certain systematic deviation from correct, intuitive discourse trees obtained by discourse parsers. In this section we are going to evaluate if there is a correlation between the deviation in CDTs and our training sets. We allow for a possibility that CDTs deviation for texts with argumentation is stronger than the one for the texts without argumentation.

**[0436]** For each source, we calculated the number of significantly deviated CDTs. For the purpose of this assessment we considered a CDT to be deviated if more than 20% of rhetoric relations is determined improperly. We do not differentiate between the specific RST relations associated with argumentation such as attribution and contrast. The distortion evaluation dataset is significantly smaller than the detection dataset since substantial manual efforts is required and the task cannot be submitted to Amazon Mechanical Turk workers.

TABLE 9

Investigation if deviation in CDT construction is dependent on the class being separated				
Source	Positive training set size	Negative training set size	Significantly deviating DTs for Positive training set, %	Significantly deviating DTs for Negative training set, %
Newspapers	30	30	15.4 ± 4.60	21.3 ± 3.85
Text style & genre recognition dataset	40	40	18.2 ± 5.21	20.7 ± 4.84
Fact and Feeling Argument annotated essays	25	25	22.3 ± 4.92	16.9 ± 5.40
	30	30	19.6 ± 3.43	17.5 ± 4.27

**[0437]** One can observe that there is no obvious correlation between the recognition classes and the rate of CDT distortion (Table 9). Hence we conclude that the training set of noisy CDTs can be adequately evaluated with respect to argumentation detection. As can be seen, there is a strong correlation between these noisy CDTs and a presence of a logical argument.

#### Sentiment

**[0438]** Because reliable sentiment detection in an arbitrary domain is challenging, we focus on a particular sentiment-

related feature such as logical argumentation with a certain polarity. Detection of logical argumentation can help improve the performance for detection of sentiment detection. We formulate sentiment detection problem at the level of paragraphs. We only detect sentiment polarity.

**[0439]** Classifying sentiment on the basis of individual words can be misleading because atomic sentiment carriers can be modified (weakened, strengthened, or reversed) based on lexical, discourse, or contextual factors. Words interact with each other to yield an expression-level polarity. For example, the meaning of a compound expression is a function of the meaning of its parts and of the syntactic rules by which they are combined. Hence, taking account of more linguistic structure than required by RST is what motivates our combination of these insights from various discourse analysis models. Our hypothesis is that it is possible to calculate the polarity values of larger syntactic elements of a text in a very accurate way as a function of the polarities of their sub-constituents, in a way similar to the ‘principle of compositionality’ in formal semantics. In other words, if the meaning of a sentence is a function of the meanings of its parts then the global polarity of a sentence is a function of the polarities of its parts. For example, we can attribute a negative trait to the verb “reduce”, but a positive polarity in “reduce the risk” even though “risk” is negative in itself (cf. the negative polarity in “reduce productivity”). This polarity reversal is only captured once we extend the analysis beyond the sentence level to calculate the global polarity of text as a whole. Hence any polarity conflict is resolved as a function of the global meaning of text, based on textual and contextual factors. The polarity weights are not properties of individual elements of text, but the function of properties operating at the level of cohesion and coherence relations latent in the syntactic, discourse and pragmatic levels of discourse analysis.

**[0440]** A number of studies has showed that discourse-related information can successfully improve the performance of sentiment analysis. For instance, one can reweigh the importance of EDUs based on their relation type or depth (Hogenboom et al, 2015a) in the DT. Some methods prune the discourse trees at certain thresholds to yield a tree of fixed depth between two and four levels. Other approaches train machine learning classifiers based on the relation types as input features (Hogenboom et al, 2015b). Most research in RDST for sentiments try to map the DT structure onto mathematically simpler representations, since it is virtually impossible to encode unstructured data of arbitrary complexity in a fixed-length vector (Markle-HuB et al 2017).

**[0441]** FIG. 37 is a fragment of a discourse tree in accordance with an aspect. FIG. 37 depicts discourse tree 3700, which represents the following text. We use the following two sentences to show that the nucleus—satellite relation does matter to determine a sentiment for an entity: [Although the camera worked well,] [I could not use it because of the viewfinder], which represents a negative sentiment about the camera; and [The camera worked well ], [although the viewfinder was inconvenient], which represents a positive sentiment about the camera.

**[0442]** For evaluation of sentiment detection, we used a dataset of positive and negative, genuine and fake travelers’ review of Chicago area hotels. See M. Ott, C. Cardie, and J. T. Hancock. 2013. Negative Deceptive Opinion Spam. In Proceedings of the 2013 Conference of the North American Chapter of the Association for Computational Linguistics:

Human Language Technologies. The authors compile the dataset for the purpose of differentiating between genuine and fake reviews. It turns out that fakeness of a review is not strongly correlated with a presence of a logical argument. Fake reviews, created by Mechanical Turn workers, back up opinions of the authors in the same way real travelers do. The test corpus contains four groups 400 reviews of 1-3 paragraphs each. 1) 400 truthful positive reviews from TripAdvisor; 2) 400 deceptive positive reviews from Mechanical Turk; 3) 400 truthful negative reviews from Expedia, Hotels.com, Orbitz, Priceline, TripAdvisor and 4) 400 deceptive negative reviews from Mechanical Turk.

**[0443]** As a baseline approach we use Stanford NLP Sentiment. We obtain the sentence-level polarity and aggregate it to the paragraphs level. Usually if an opinion is positive, the author just enumerates what she likes. However, if an opinion is negative, in many cases the author would try to back it up, perform a comparison, explanation, arguments for why he is right and his assessment is adequate.

**[0444]** Hence the rule for integration of a default and argumentation-based sentiment detectors are as follows (Table 10). This rule is oriented towards consumer review data and would need modifications to better treat other text genre.

TABLE 10

Integration rule			
Decision of a logical argument detector			
Decision of a default sentiment detector	0 (no argument)	1 (possibly some argument)	2 (strong argument)
-1	0	-1	-1
0	0	0	-1
+1	+1	+1	-1

**[0445]** The case below is a borderline positive review, and it can easily be flipped to become negative: “Like all hotels in Chicago, this hotel caters to wealthy and/or business clients with very high parking price. However, if you are aware of that prior to arrival, it’s not a big deal. It makes sense to find a different place to park the car and bring your own snacks for the room. It would be nice though if hotels such as the Swissotel had a fridge in the room for guest use. Staff was very helpful. Overall, if I can get a good rate again, I’ll stay at the Swissotel the next time I am in Chicago.” This text looks overall like a negative review from the DT standpoint. Most reviews with similar DTs are negative.

**[0446]** FIG. 38 depicts a discourse tree for a borderline review in accordance with an aspect. FIG. 38 depicts discourse tree 3800 for a borderline review. A borderline review is negative from the discourse point of view and neutral from the reader’s standpoint.

#### Extending Compositionality Semantics Towards Discourse

**[0447]** Let us look how the sentiment in first sentence is assessed by Semantic Compositionality model. See R. Socher, A. Perelygin, J. Wu, J. Chuang, C. Manning, A. Ng and C. Potts. Recursive Deep Models for Semantic Compositionality Over a Sentiment Treebank. Conference on Empirical Methods in Natural Language Processing (EMNLP 2013). Judging by individual words and their composition, it is hard to understand that ‘high price’ have

a negative sentiment value here. In the movie database for training, ‘high’ is assigned the positive sentiment, and most likely ‘high price’ is not tagged as negative. Even if ‘high price’ is recognized as negative, it would be hard to determine how the rest of the tree would affect it, such as the phrase ‘wealthy and/or business clients’. Notice that in the movie domain the words of this phrase are not assigned adequate sentiments either.

**[0448]** It is rather hard to determine the sentiment polarity of this sentence alone, given its words and phrasing. Instead, taking into account the discourse of the consecutive sentences, the overall paragraph sentiment and the one of the given sentence can be determined with a higher accuracy.

**[0449]** FIG. 39 depicts a discourse tree for a sentence showing compositional semantic approach to sentiment analysis in accordance with an aspect. FIG. 39 depicts discourse tree 3900.

**[0450]** We state that sentiment analysis benefiting from the ‘compositional semantics’ insights would accurately assign polarity sentiment in the example above if the analysis captures not only word ‘high’ (assigned negative sentiment polarity), phrase ‘high price’ (with negative sentiment polarity) or sentence level structure ‘Like all . . . price’ (where sentiment polarity is difficult to determine because we need to read the whole text for a global sentiment polarity attribution). Sentiment analysis is calculated based on global polarity, not dependent on individual elements of the sentence, but more interestingly, on the discourse level structure (macro-structure). For example, “high reliability” is neutral in “I want a car with high reliability” because though it is a positive property, it does not refer to any specific car.

## Results

**[0451]** The baseline system (Socher et al., 2013) is trained on a different domain than the test domain since our evaluation of sentiment detection is domain-independent.

**[0452]** The results of sentiment analysis achieved by the hybrid compositional semantics and discourse analysis are shown in Table 11. In the first row we show the accuracy of the baseline system on our data. In the second grayed row we show the improvement by means of the hybrid system. This improvement is achieved by discovering overall negative sentiment at the paragraph level in case of recognized presence of argumentation. In some of these cases the negative sentiment is implicit and can only be detected indirectly from the discourse structure, where individual words do not indicate negative sentiments.

TABLE 11

Evaluation of sentiment analysis			
Data source and method	Precision	Recall	F
Baseline (Standard NLP)	62.7	68.3	65.38
Hybrid sentiment detector (Stanford NLP + SVM TK for CDT)	79.3	81.0	80.14
Sentiment detector via SVM TK for DT	67.5	69.4	68.44
Sentiment detector via SVM TK for CDT	69.8	68.3	69.04
Untruthful opinion data detector, positive reviews (SVM TK for parse thicket)	81.2	74.9	77.92
Untruthful opinion data detector, negative reviews (for parse thicket)	78.3	74.7	76.46

**[0453]** We investigate a stand-alone SVM TK sentiment recognition system with various representations (rows three

to five). CDT representation outperforms parse thickets and DT ones. With simpler representation which does not take into account discourse-level information at all, sentiment recognition accuracy is fairly low (not shown).

**[0454]** We also explored whether fake opinionated text have different rhetoric structure to genuine one. See Jindal and Liu, Opinion Spam and Analysis, Department of Computer Science, University of Illinois at Chicago, 2008. Jindal and Liu addressed the problem of detection of disruptive opinion spam: obvious instances that are easily identified by a human reader, e.g., advertisements, questions, and other irrelevant or non-opinion texts. (Ott et al. investigated potentially more insidious type of opinion spam such as deceptive opinion spam, ones that have been deliberately written to sound authentic, in order to deceive the reader. See M. Ott, Y. Choi, C. Cardie, and J. T. Hancock. 2011. Finding Deceptive Opinion Spam by Any Stretch of the Imagination. In Proceedings of the 49th Annual Meeting of the Association for Computational Linguistics: Human Language Technologies. Fake reviews were written by Amazon Mechanical Turk workers. The instructions asked the workers to assume that they are employed by a hotel’s marketing department, and to pretend that they are asked to write a fake review (as if they were a customer) to be posted on a travel review website; additionally, the review needs to sound realistic and portray the hotel in a positive light. A request for negative reviews is done analogously.

**[0455]** Although our SVM TK system did not achieve performance of 90%, the task of detection of fake review texts was performed (at 76-77% accuracy, two bottom greyed rows) by the universal text classification system, the same which extracts arguments and assesses sentiments polarity.

## Validation of Arguments

**[0456]** Aspects of the present disclosure validate argumentation. To be convincing, a text or an utterance includes a valid argument. Rhetoric classification application 102 extracts an argumentation structure from a body of text and represents the argumentation via a communicative discourse tree (CDT). Subsequently, rhetoric classification application 102 can verify that the claim, or target claim, in the text is valid, i.e., is not logically attacked by other claims, and is consistent with external truths, i.e., rules. With domain knowledge, the validity of a claim can be validated. However, in some cases, domain knowledge may be unavailable and other domain-independent information, such as writing style and writing logic, are used.

**[0457]** Certain aspects enable applications such as Customer Relationship Management (CRM). CRM addresses handling customer complaints (Galitsky and de la Rosa 2011). In customer complaints, authors are upset with products or services they received, as well as how an issue was communicated by customer support. Complainants frequently write complaints in a very strong, emotional language, which may distort the logic of argumentation and therefore make a judgment on complaint validity difficult. Both affective and logical argumentation is heavily used.

**[0458]** To facilitate improved autonomous agents, certain aspects use argument-mining, which is a linguistic-based, and logical validation of an argument, which is logic based. The concept of automatically identifying argumentation schemes was first discussed in (Walton et al., 2008). Ghosh et al. (2014) investigates argumentation discourse structure



of a specific type of communication—online interaction threads. Identifying argumentation in text is connected to the problem of identifying truth, misinformation and disinformation on the web (Pendyala and Figueira, 2015, Galitsky 2015, Pisarevskaya et al 2015). In (Lawrence and Reed, 2015) three types of argument structure identification are combined: linguistic features, topic changes and machine learning. As explained further herein, some aspects employ Defeasible Logic Programming (DeLP) (Garcia and Simari, 2004; Alsinet et al., 2008) in conjunction with communicative discourse trees.

[0459] FIG. 40 depicts an exemplary process 4000 for validating arguments in accordance with an aspect. Rhetoric classification application 102 can perform process 4000.

[0460] At block 4001, process 4000 involves accessing text that includes fragments. At block 4001, process 4000 performs substantially similar steps as described in block 3601 of process 3600. Text can include input text 130, which can be a paragraph, sentence, utterance, or other text.

[0461] At block 4002, process 4000 involves identifying a presence of argumentation in a subset of the text by creating a communicative discourse tree from the text and applying a classification model trained to detect argumentation to the communicative discourse tree. At block 4002, process 4000 performs substantially similar steps as described in blocks 3602-3604 of process 3600. Other methods of argumentation detection can be used.

[0462] A block 4003, process 4000 involves evaluating the argumentation by using a logic system. Rhetoric classification application 102 can use different types of logic systems to evaluate the argumentation. For example, Defeasible Logic Programming (DeLP) can be used. FIG. 42 depicts exemplary operations that can implement block 4003. For illustrative purposes, process 4000 is discussed with respect to FIG. 41.

[0463] FIG. 41 depicts an exemplary communicative discourse tree for an argument in accordance with an aspect. FIG. 41 includes communicative discourse tree 4101. Communicative discourse tree 4101 includes node 4120 and other nodes, some of which are labeled with communicative actions 4110-4117.

[0464] In an example, a judge hears an eviction case and wants to make a judgment on whether rent was provably paid (deposited) or not (denoted as rent receipt). An input is a text where a defendant is expressing his point. CDT 4101 represents the following text: “The landlord contacted me, the tenant, and the rent was requested. However, I refused the rent since I demanded repair to be done. I reminded the landlord about necessary repairs, but the landlord issued the three-day notice confirming that the rent was overdue. Regretfully, the property still stayed unrepaired.”

[0465] FIG. 42 depicts an exemplary method for validating arguments using defeasible logic programming in accordance with an aspect. Defeasible logic programming (DeLP) is a set of facts, strict rules  $\Pi$  of the form (A:-B), and a set of defeasible rules  $\Delta$  of the form  $A \leftarrow B$ , whose intended meaning is “if B is the case, then usually A is also the case.” Let  $P = (\Pi, \Delta)$  be a DeLP program and L a ground literal. Strict rules cannot be changed, even based on opinion. In contrast, a defeasible rule can be false in some cases.

[0466] In the above example, underlined words form the clause in DeLP, and the other expressions can form the facts. An example of a fact is “rent\_refused,” i.e. that a landlord refused rent. An example of a strict rule is “the earth is flat.”

An example of a defeasible rule is “rent\_receipt  $\leftarrow$  rent\_deposit transaction,” which means that, usually if “rent\_deposit transaction” then “rent receipt” (rent is received). But a defeasible rule may not always be true, for example, if the rent is deposited in the wrong account or there is an error at the bank.

[0467] Rhetoric classification application 102 can use results from the communicative discourse tree developed at block 4002 as inputs for the DeLP. The communicative discourse tree indicates valuable information, such as how the facts are inter-connected by defeasible rules. Elementary discourse units of the CDT that are of rhetorical relation type “contrast” and communicative actions that are of type “disagree” indicate defeasible rules.

[0468] At block 4201, method 4200 involves creating a fixed part of a logic system. The fixed part of the logic system includes one or more claim terms and one or more domain definition clauses. Domain definition clauses are associated with a domain of the text and can include legal, scientific terms, and commonsense knowledge in a particular domain. A scientific example is “if a physical body is moving with acceleration, it is subject to a physical force.” In the area of landlord-tenant law, an example of a standard definition is: “if repair is done  $\rightarrow$  home is habitable and appliances are working.”

[0469] Continuing the above example, the text contains a target claim to be evaluated “rent\_receipt,” i.e. “was the rent received?” Rhetoric classification application 102 also extracts the following clause “repair\_is\_done  $\leftarrow$  rent\_refused” from the text “refused the rent since I demanded repair to be done.”

[0470] At block 4202, method 4200 involves creating a variable part of the logic system by determining a set of defeasible rules and a set of facts. Rhetoric classification application 102 determines, from the communicative discourse tree, a set of defeasible rules by extracting, from the communicative discourse tree, one or more of (i) an elementary discourse unit that is a rhetorical relation type contrast and (ii) a communicative action that is of a class type disagree. The class disagree includes actions such as “deny,” “have different opinion,” “not believe,” “refuse to believe,” “contradict,” “diverge,” “deviate,” “counter,” “differ,” “disent,” “be dissimilar.” Other examples are possible.

[0471] Rhetoric classification application 102 determines the following defeasible rules:

[0472] rent\_receipt  $\leftarrow$  rent\_deposit transaction,

[0473] rent\_deposit transaction  $\leftarrow$  contact\_tenant.

[0474] ]rent\_deposit transaction  $\leftarrow$  contact\_tenant, three\_days\_notice\_is\_issued.

[0475] ]rent\_deposit transaction  $\leftarrow$  rent\_is\_overdue.

[0476] ]repair\_is\_done  $\leftarrow$  rent\_refused, repair\_is\_done.

[0477] repair\_is\_done  $\leftarrow$  rent\_is\_requested.

[0478] ]rent\_deposit transaction  $\leftarrow$  tenant\_short\_on\_money, repair\_is\_done.

[0479] ]repair\_is\_done  $\leftarrow$  repair\_is\_requested.

[0480] ]repair\_is\_done  $\leftarrow$  rent\_is\_requested.

[0481] ]repair\_is\_requested  $\leftarrow$  stay\_unrepaired. ]repair\_is\_done  $\leftarrow$  stay\_unrepaired.

[0482] Additionally, rhetoric classification application 102 determines additional facts from communicative actions that are of type “disagree.” Continuing the example, and referring back to FIG. 41, rhetoric classification application 102 determines the following facts from the subjects of the communicative actions of the CDT: contact\_tenant (com-

municative action **4111**), `rent_is_requested` (communicative action **4112**), `rent_refused` (communicative action **4113**), `stay_unrepaired` (communicative action **4114**), `remind_about_repair` (communicative action **4115**), `three_days_notice_is_issued` (communicative action **4116**), and `rent_is_overdue` (communicative action **4117**).

**[0483]** At block **4203**, method **4200** involves determining a defeasible derivation comprising a set of non-contradictory defeasible rules from the defeasible set of rules. A defeasible derivation of  $L$  from  $P$  consists of a finite sequence  $L_1, L_2, \dots, L_n=L$  of ground literals, such that each literal  $L_i$  is in the sequence because: (a)  $L_i$  is a fact in  $\Pi$ , or (b) there exists a rule  $R_i$  in  $P$  (strict or defeasible) with head  $L_i$  and body  $B_i, B_2, \dots, B_k$  and every literal of the body is an element  $L_j$  of the sequence appearing before  $L_i$  ( $j < i$ ). Let  $h$  be a literal, and  $P=(\Pi, \Delta)$  a DeLP program. We say that  $\langle A, h \rangle$  is an argument for  $h$ , if  $A$  is a set of defeasible rules of  $A$ , such that:

**[0484]** 1. there exists a defeasible derivation for  $h$  from  $(\Pi \cup A)$ ;

**[0485]** 2. the set  $(\Pi \cup A)$  is non-contradictory; and

**[0486]** 3.  $A$  is minimal: there is no proper subset  $A_0$  of  $A$  such that  $A_0$  satisfies conditions (1) and (2).

**[0487]** Hence an argument  $\langle A, h \rangle$  is a minimal non-contradictory set of defeasible rules, obtained from a defeasible derivation for a given literal  $h$  associated with a program  $P$ . As discussed above, a minimal subset means that no subset exists that satisfies conditions 1 and 2.

**[0488]** At block **4204**, method **4200** involves creating one or more defeater arguments from the set of facts. Defeaters are arguments which can be in their turn attacked by other arguments, as is the case in a human dialogue. An argumentation line is a sequence of arguments where each element in a sequence defeats its predecessor. In the case of DeLP, there are a number of acceptability requirements for argumentation lines in order to avoid fallacies (such as circular reasoning by repeating the same argument twice).

**[0489]** Defeater arguments can be formed in the following manner. For example, argument  $\langle A_1, h_1 \rangle$  attacks  $\langle A_2, h_2 \rangle$  iff (if and only if) there exists a sub-argument  $\langle A, h \rangle$  of  $\langle A_2, h_2 \rangle$  ( $A \subseteq A_2$ ) such that  $h$  and  $h_1$  are inconsistent (i.e.  $\Pi \cup \{h, h_1\}$  derives complementary literals). We will say that  $\langle A_1, h_1 \rangle$  defeats  $\langle A_2, h_2 \rangle$  if  $\langle A_1, h_1 \rangle$  attacks  $\langle A_2, h_2 \rangle$  at a sub-argument  $\langle A, h \rangle$  and  $\langle A_1, h_1 \rangle$  is strictly preferred (or not comparable to)  $\langle A, h \rangle$ . In the first case we will refer to  $\langle A_1, h_1 \rangle$  as a proper defeater, whereas in the second case it will be a blocking defeater.

**[0490]** At block **4205**, method **4200** involves constructing, from the defeasible derivation, a dialectic tree including a root node representing the argument and leaf nodes that represent the defeater arguments. Target claims can be considered DeLP queries which are solved in terms of dialectical trees, which subsumes all possible argumentation lines for a given query. The definition of dialectical tree provides us with an algorithmic view for discovering implicit self-attack relations in users' claims. Let  $\langle A_0, h_0 \rangle$  be an argument (target claim) from a program  $P$ . For discussion purposes, block **4205** is discussed with respect to FIG. **43**.

**[0491]** FIG. **43** depicts an exemplary dialectic tree in accordance with an aspect. FIG. **43** depicts the dialectical tree for the text developed above. FIG. **43** includes dialectic

tree **4300**, which includes root node **4301** and nodes **4302-4307**. Dialectical tree **4300** is based on  $\langle A_0, h_0 \rangle$ , which is defined as follows:

**[0492]** 1. The root of the tree (root node **4301**) is labeled with  $\langle A_0, h_0 \rangle$

**[0493]** 2. Let  $N$  be a non-root vertex of the tree labeled  $\langle A_n, h_n \rangle$  and  $\Lambda = [\langle A_0, h_0 \rangle, \langle A_1, h_1 \rangle, \dots, \langle A_n, h_n \rangle]$  (the sequence of labels of the path from the root to  $N$ ). Let  $[\langle B_0, q_0 \rangle, \langle B_1, q_1 \rangle, \dots, \langle B_k, q_k \rangle]$  all attack  $\langle A_n, h_n \rangle$ . For each attacker  $\langle B_i, q_i \rangle$  with acceptable argumentation line  $[\Lambda, \langle B_i, q_i \rangle]$ , we have an arc between  $N$  and its child  $N_i$ .

**[0494]** A labeling on the dialectical tree can be then performed as follows:

**[0495]** 1. All leaves (nodes **4302-4307**) are to be labeled as U-nodes (undefeated nodes).

**[0496]** 2. Any inner node is to be labeled as a U-node whenever all of its associated children nodes are labeled as D-nodes.

**[0497]** 3. Any inner node is to be labeled as a D-node whenever at least one of its associated children nodes is labeled as U-node.

**[0498]** At block **4206**, method **4200** involves evaluating the dialectic tree by recursively evaluating the defeater arguments.

**[0499]** In the DeLP example, the literal `rent receipt` is supported by  $\langle A, \text{rent\_receipt} \rangle = \langle \{(\text{rent\_receipt} \text{--} \text{rent\_deposit\_transaction}), (\text{rent\_deposit\_transaction} \text{--} \text{tenant\_short\_on\_money})\}, \text{rent\_receipt} \rangle$  and there exist three defeaters for it with three respective argumentation lines:

**[0500]** (1)  $\langle B_1, \text{rent deposit transaction} \rangle = \langle \{(\text{rent\_deposit\_transaction} \text{--} \text{tenant\_short\_on\_money, three\_days\_notice\_is\_issued})\}, \text{rent\_deposit\_transaction} \rangle$ .

**[0501]** (2)  $\langle B_2, \text{rent deposit transaction} \rangle = \langle \{(\text{rent\_deposit\_transaction} \text{--} \text{tenant\_short\_on\_money, repair\_is\_done}), (\text{repair\_is\_done} \text{--} \text{rent\_refused})\}, \text{rent\_deposit\_transaction} \rangle$ .

**[0502]** (3)  $\langle B_3, \text{rent deposit transaction} \rangle = \langle \{(\text{rent\_deposit\_transaction} \text{--} \text{rent\_is\_overdue})\}, \text{rent\_deposit\_transaction} \rangle$ .

**[0503]** (1) and (2) are proper defeaters and the last one is a blocking defeater. Observe that the first argument structure has the counter-argument,  $\langle \text{rent\_deposit\_transaction} \text{--} \text{tenant\_short\_on\_money} \rangle$ , `rent_deposit_transaction`,

but it is not a defeater because the former is more specific. Thus, no defeaters exist and the argumentation line ends there.

**[0504]**  $B_3$  above has a blocking defeater  $\langle \{(\text{rent\_deposit\_transaction} \text{--} \text{tenant\_short\_on\_money})\}, \text{rent\_deposit\_transaction} \rangle$ , which is a disagreement sub-argument of  $\langle A, \text{rent\_receipt} \rangle$  and it cannot be introduced since it gives rise to an unacceptable argumentation line.  $B_2$  has two defeaters which can be introduced:  $\langle C_1, \text{repair\_is\_done} \rangle$ , where  $C_1 = \langle \{(\text{repair\_is\_done} \text{--} \text{rent\_refused, repair\_is\_done}), (\text{repair\_is\_done} \text{--} \text{rent\_is\_requested})\}, \text{repair\_is\_done} \rangle$ , a proper defeater, and  $\langle C_2, \text{repair\_is\_done} \rangle$ , where  $C_2 = \langle \{(\text{repair\_is\_done} \text{--} \text{repair\_is\_requested})\}, \text{repair\_is\_done} \rangle$  is a blocking defeater. Hence one of these lines is further split into two;  $C_1$  has a blocking defeater that can be introduced in the line  $\langle D_1, \text{repair\_is\_done} \rangle$ , where  $D_1 = \langle \{(\text{repair\_is\_done} \text{--} \text{stay\_unrepaired})\}, \text{repair\_is\_done} \rangle$ .  $D_1$  and  $C_2$  have a blocking defeater, but they cannot be introduced because they make the argumentation line inac-

ceptable. Hence the state\_rent receipt cannot be reached, as the argument supporting the literal rent receipt, is not warranted.

**[0505]** At block 4207, method 4200 involves responsive to determining that none of the defeater arguments are contradictory with the defeasible derivation, identifying the claim supported by the argument as valid. A determination that no contradictory arguments exists indicates that the claim is valid, whereas a determination that contradictory arguments exists indicates that the claim is invalid. Rhetoric classification 102 can then perform an action based on the validation, such as providing different answers to a user device based on the validity of the claim.

#### Argument Validation Results

**[0506]** Argument validation is evaluated based on argument detection (by linguistic means) and then validation (logical means). A dataset of 623 legal cases scraped from Landlord vs Tenant (2018) is formed. Each year this website provides more than 700 summaries of recent landlord-tenant court cases and agency decisions. Landlord v. Tenant covers more than a dozen courts and agencies, including the NYC Civil Court, NYS Division of Housing and Community Renewal (DHCR), NYC Environmental Control Board, and many more. The website allows users to get access to their dynamic database of cases that go back to 1993 and the New York Landlord v. Tenant newsletter archives, as well as to run searches for designated case summaries. Full-text case decisions and opinion letters are also available from this source.

**[0507]** A typical case abstract is like the following: “Tenants complained of a reduction in building-wide services. They said that the building super didn’t make needed repairs as requested and that landlord had refused to perform repairs in their apartment. They also complained about building accessibility issues. Among other things, the building side door walkway was reconstructed and made narrower. This made it hard to navigate a wheelchair through that doorway. The DRA ruled against tenants, who appealed and lost.” Firstly, we extract sentences containing argumentation and then attempt to find a claim being communicated, from our DeLP ontology. The claim to be validated in the above example is `repair_is_done`. We then subject this claim to validation. We obtain the claim validity value from the tags on the web page assigned by the judge who heard the case, such as `rent_reduction_denied`. Table 12, below shows evaluation results being communicated with argumentation in landlord versus tenant case texts.

TABLE 12

Method/sources	P	R	F1
Bag-of-words	53.1	56.8	54.89
WEKA-Naive Bayes	60.1	58.8	59.44
SVM TK for RST and CA (full parse trees)	75.7	75.5	75.60
SVM TK for DT	61.2	63.8	62.47
SVM TK for CDT	81.9	77.5	79.64

**[0508]** For the argument detection task, we use this landlord vs tenant as a positive training set. As a negative dataset, we use various text sources which should contain neither argumentation nor opinionated data. We used Wikipedia, factual news sources, and also the component of (Lee, 2001)

dataset that includes such sections of the corpus as: [‘tells’], instructions for how to use software; [‘tele’], instructions for how to use hardware, and [news], a presentation of a news article in an objective, independent manner, and others. Further details on the negative, argumentation-free data sets are available in (Galitsky et al 2018 and Chapter 10).

**[0509]** A baseline argument detection approach relies on keywords and syntactic features to detect argumentation (Table 13.8). Frequently, a coordinated pair of communicative actions (so that at least one has a negative sentiment polarity related to an opponent) is a hint that logical argumentation is present. This naive approach is outperformed by the top performing TK learning CDT approach by 29%. SVM TK of CDT outperforms SVM TK for RST+CA and RST+full parse trees (Galitsky, 2017) by about 5% due to noisy syntactic data which is frequently redundant for argumentation detection.

**[0510]** SVM TK approach provides acceptable F-measure but does not help to explain how exactly the affective argument identification problem is solved, providing only final scoring and class labels. Nearest neighbor maximal common sub-graph algorithm is much more fruitful in this respect (Galitsky et al., 2015). Comparing the bottom two rows, we observe that it is possible, but infrequent to express an affective argument without CAs.

**[0511]** Assessing logical arguments extracted from text, we were interested in cases where an author provides invalid, inconsistent, self-contradicting cases. That is important for chatbot as a front end of a CRM systems focused on customer retention and facilitating communication with a customer (Galitsky et al., 2009). The domain of residential real estate complaints was selected and a DeLP thesaurus was built for this domain. Automated complaint processing system can be essential, for example, for property management companies in their decision support procedures (Constantinos et al., 2003).

TABLE 13.9

Evaluation results for the whole argument validation pipeline				
Types of complaints	P	R	F1 of validation	F1 of total
Single rhetoric relation of type contrast	87.3	15.6	26.5	18.7
Single communicative action of type disagree	85.2	18.4	30.3	24.8
Couple of rhetoric relation including contrast, cause, temporal, attribution	86.2	22.4	35.6	23.9
Couple of rhetoric relation above plus couple of communication actions disagree, deny responsibility, argue	82.4	20.7	33.1	25.1
Two or three specific relations or communicative actions	80.2	20.6	32.8	25.4
Four and above specific relations or communicative actions	86.3	16.5	27.7	21.7

**[0512]** In our validity assessment we focus on target features related to how a given complaint needs to be handled, such as `compensation_required`, `proceed_with_eviction`, `rent_receipt` and others.

**[0513]** Validity assessment results are shown in Table 13.9. In the first and second rows, we show the results of the simplest complaint with a single rhetoric relation such as contrast and a single CA indicating an extracted argumentation attack relation respectively. In the third and fourth rows we show the validation results for legal cases with two

non-default rhetorical relations and two CAs of the disagreement type, correspondingly. In the fifth row we assess complaints of average complexity, and in the bottom row, the most complex, longer complaints in terms of their CDTs. The third column shows detection accuracy for invalid argumentation in complaints in a stand-alone argument validation system. Finally, the fourth column shows the accuracy of the integrated argumentation extraction and validation system.

[0514] In our validity assessment, we focus on target features (claims) related to what kind of verdict needs to be issued, such as *compensation\_required*, *proceed\_with\_eviction*, *rent\_receipt* and others. System decision is determined by whether the identified claim is validated or not: if it is validated, then the verdict is in favor of this claim, and if not validated, decides against this claim.

[0515] In these results recall is low because in the majority of cases the invalidity of claims is due to factors other than being self-defeated. Precision is relatively high since if a logical flaw in an argument is established, most likely the whole claim is invalid because other factors besides argumentation (such as false facts) contribute as well. As complexity of a complaint and its discourse tree grows, F1 first improves since more logical terms are available and then goes back down as there is a higher chance of a reasoning error due to a noisier input.

[0516] For decision support systems, it is important to maintain a low false positive rate. It is acceptable to miss invalid complaints, but for a detected invalid complaint, confidence should be rather high. If a human agent is recommended to look at a given complaint as invalid, her expectations should be met most of the time. Although F1-measure of the overall argument detection and validation system is low in comparison with modern recognition systems, it is still believed to be usable as a component of a CRM decision-support system.

[0517] FIG. 44 depicts a simplified diagram of a distributed system 4400 for implementing one of the aspects. In the illustrated aspect, distributed system 4400 includes one or more client computing devices 4402, 4404, 4406, and 4408, which are configured to execute and operate a client application such as a web browser, proprietary client (e.g., Oracle Forms), or the like over one or more network(s) 4410. Server 4412 may be communicatively coupled with remote client computing devices 4402, 4404, 4406, and 4408 via network 4410.

[0518] In various aspects, server 4412 may be adapted to run one or more services or software applications provided by one or more of the components of the system. The services or software applications can include nonvirtual and virtual environments. Virtual environments can include those used for virtual events, tradeshow, simulators, classrooms, shopping exchanges, and enterprises, whether two- or three-dimensional (3D) representations, page-based logical environments, or otherwise. In some aspects, these services may be offered as web-based or cloud services or under a Software as a Service (SaaS) model to the users of client computing devices 4402, 4404, 4406, and/or 4408. Users operating client computing devices 4402, 4404, 4406, and/or 4408 may in turn utilize one or more client applications to interact with server 4412 to utilize the services provided by these components.

[0519] In the configuration depicted in the figure, the software components 4418, 4420 and 4422 of system 4400

are shown as being implemented on server 812. In other aspects, one or more of the components of system 4400 and/or the services provided by these components may also be implemented by one or more of the client computing devices 4402, 4404, 4406, and/or 4408. Users operating the client computing devices may then utilize one or more client applications to use the services provided by these components. These components may be implemented in hardware, firmware, software, or combinations thereof. It should be appreciated that various different system configurations are possible, which may be different from distributed system 4400. The aspect shown in the figure is thus one example of a distributed system for implementing an aspect system and is not intended to be limiting.

[0520] Client computing devices 4402, 4404, 4406, and/or 4408 may be portable handheld devices (e.g., an iPhone®, cellular telephone, an iPad®, computing tablet, a personal digital assistant (PDA)) or wearable devices (e.g., a Google Glass® head mounted display), running software such as Microsoft Windows Mobile®, and/or a variety of mobile operating systems such as iOS, Windows Phone, Android, BlackBerry 10, Palm OS, and the like, and being Internet, e-mail, short message service (SMS), Blackberry®, or other communication protocol enabled. The client computing devices can be general purpose personal computers including, by way of example, personal computers and/or laptop computers running various versions of Microsoft Windows®, Apple Macintosh®, and/or Linux operating systems. The client computing devices can be workstation computers running any of a variety of commercially-available UNIX® or UNIX-like operating systems, including without limitation the variety of GNU/Linux operating systems, such as for example, Google Chrome OS. Alternatively, or in addition, client computing devices 4402, 4404, 4406, and 4408 may be any other electronic device, such as a thin-client computer, an Internet-enabled gaming system (e.g., a Microsoft Xbox gaming console with or without a Kinect® gesture input device), and/or a personal messaging device, capable of communicating over network(s) 4410.

[0521] Although exemplary distributed system 4400 is shown with four client computing devices, any number of client computing devices may be supported. Other devices, such as devices with sensors, etc., may interact with server 4412.

[0522] Network(s) 4410 in distributed system 4400 may be any type of network familiar to those skilled in the art that can support data communications using any of a variety of commercially-available protocols, including without limitation TCP/IP (transmission control protocol/Internet protocol), SNA (systems network architecture), IPX (Internet packet exchange), AppleTalk, and the like. Merely by way of example, network(s) 4410 can be a local area network (LAN), such as one based on Ethernet, Token-Ring and/or the like. Network(s) 4410 can be a wide-area network and the Internet. It can include a virtual network, including without limitation a virtual private network (VPN), an intranet, an extranet, a public switched telephone network (PSTN), an infra-red network, a wireless network (e.g., a network operating under any of the Institute of Electrical and Electronics (IEEE) 802.44 suite of protocols, Bluetooth®, and/or any other wireless protocol); and/or any combination of these and/or other networks.

[0523] Server 4412 may be composed of one or more general purpose computers, specialized server computers

(including, by way of example, PC (personal computer) servers, UNIX® servers, mid-range servers, mainframe computers, rack-mounted servers, etc.), server farms, server clusters, or any other appropriate arrangement and/or combination. Server **4412** can include one or more virtual machines running virtual operating systems, or other computing architectures involving virtualization. One or more flexible pools of logical storage devices can be virtualized to maintain virtual storage devices for the server. Virtual networks can be controlled by server **4412** using software defined networking. In various aspects, server **4412** may be adapted to run one or more services or software applications described in the foregoing disclosure. For example, server **4412** may correspond to a server for performing processing described above according to an aspect of the present disclosure.

**[0524]** Server **4412** may run an operating system including any of those discussed above, as well as any commercially available server operating system. Server **4412** may also run any of a variety of additional server applications and/or mid-tier applications, including HTTP (hypertext transport protocol) servers, FTP (file transfer protocol) servers, CGI (common gateway interface) servers, JAVA® servers, database servers, and the like. Exemplary database servers include without limitation those commercially available from Oracle, Microsoft, Sybase, IBM (International Business Machines), and the like.

**[0525]** In some implementations, server **4412** may include one or more applications to analyze and consolidate data feeds and/or event updates received from users of client computing devices **802**, **804**, **806**, and **808**. As an example, data feeds and/or event updates may include, but are not limited to, Twitter® feeds, Facebook® updates or real-time updates received from one or more third party information sources and continuous data streams, which may include real-time events related to sensor data applications, financial tickers, network performance measuring tools (e.g., network monitoring and traffic management applications), click-stream analysis tools, automobile traffic monitoring, and the like. Server **4412** may also include one or more applications to display the data feeds and/or real-time events via one or more display devices of client computing devices **4402**, **4404**, **4406**, and **4408**.

**[0526]** Distributed system **4400** may also include one or more databases **4414** and **4416**. Databases **4414** and **4416** may reside in a variety of locations. By way of example, one or more of databases **4414** and **4416** may reside on a non-transitory storage medium local to (and/or resident in) server **4412**. Alternatively, databases **4414** and **4416** may be remote from server **4412** and in communication with server **4412** via a network-based or dedicated connection. In one set of aspects, databases **4414** and **4416** may reside in a storage-area network (SAN). Similarly, any necessary files for performing the functions attributed to server **4412** may be stored locally on server **4412** and/or remotely, as appropriate. In one set of aspects, databases **4414** and **4416** may include relational databases, such as databases provided by Oracle, that are adapted to store, update, and retrieve data in response to SQL-formatted commands.

**[0527]** FIG. **45** is a simplified block diagram of one or more components of a system environment **4500** by which services provided by one or more components of an aspect system may be offered as cloud services in accordance with an aspect of the present disclosure. In the illustrated aspect,

system environment **4500** includes one or more client computing devices **4504**, **4506**, and **4508** that may be used by users to interact with a cloud infrastructure system **4502** that provides cloud services. The client computing devices may be configured to operate a client application such as a web browser, a proprietary client application (e.g., Oracle Forms), or some other application, which may be used by a user of the client computing device to interact with cloud infrastructure system **4502** to use services provided by cloud infrastructure system **4502**.

**[0528]** It should be appreciated that cloud infrastructure system **4502** depicted in the figure may have other components than those depicted. Further, the aspect shown in the figure is only one example of a cloud infrastructure system that may incorporate an aspect of the invention. In some other aspects, cloud infrastructure system **4502** may have more or fewer components than shown in the figure, may combine two or more components, or may have a different configuration or arrangement of components.

**[0529]** Client computing devices **4504**, **4506**, and **4508** may be devices similar to those described above for **4402**, **4404**, **4406**, and **4408**.

**[0530]** Although exemplary system environment **4500** is shown with three client computing devices, any number of client computing devices may be supported. Other devices such as devices with sensors, etc. may interact with cloud infrastructure system **4502**.

**[0531]** Network(s) **4510** may facilitate communications and exchange of data between clients **4504**, **4506**, and **4508** and cloud infrastructure system **4502**. Each network may be any type of network familiar to those skilled in the art that can support data communications using any of a variety of commercially-available protocols, including those described above for network(s) **4410**.

**[0532]** Cloud infrastructure system **4502** may comprise one or more computers and/or servers that may include those described above for server **4412**.

**[0533]** In certain aspects, services provided by the cloud infrastructure system may include a host of services that are made available to users of the cloud infrastructure system on demand, such as online data storage and backup solutions, Web-based e-mail services, hosted office suites and document collaboration services, database processing, managed technical support services, and the like. Services provided by the cloud infrastructure system can dynamically scale to meet the needs of its users. A specific instantiation of a service provided by cloud infrastructure system is referred to herein as a "service instance." In general, any service made available to a user via a communication network, such as the Internet, from a cloud service provider's system is referred to as a "cloud service." Typically, in a public cloud environment, servers and systems that make up the cloud service provider's system are different from the customer's own on-premises servers and systems. For example, a cloud service provider's system may host an application, and a user may, via a communication network such as the Internet, on demand, order and use the application.

**[0534]** In some examples, a service in a computer network cloud infrastructure may include protected computer network access to storage, a hosted database, a hosted web server, a software application, or other service provided by a cloud vendor to a user, or as otherwise known in the art. For example, a service can include password-protected access to remote storage on the cloud through the Internet.

As another example, a service can include a web service-based hosted relational database and a script-language middleware engine for private use by a networked developer. As another example, a service can include access to an email software application hosted on a cloud vendor's web site.

**[0535]** In certain aspects, cloud infrastructure system **4502** may include a suite of applications, middleware, and database service offerings that are delivered to a customer in a self-service, subscription-based, elastically scalable, reliable, highly available, and secure manner. An example of such a cloud infrastructure system is the Oracle Public Cloud provided by the present assignee.

**[0536]** Large volumes of data, sometimes referred to as big data, can be hosted and/or manipulated by the infrastructure system on many levels and at different scales. Such data can include data sets that are so large and complex that it can be difficult to process using typical database management tools or traditional data processing applications. For example, terabytes of data may be difficult to store, retrieve, and process using personal computers or their rack-based counterparts. Such sizes of data can be difficult to work with using most current relational database management systems and desktop statistics and visualization packages. They can require massively parallel processing software running thousands of server computers, beyond the structure of commonly used software tools, to capture, curate, manage, and process the data within a tolerable elapsed time.

**[0537]** Extremely large data sets can be stored and manipulated by analysts and researchers to visualize large amounts of data, detect trends, and/or otherwise interact with the data. Tens, hundreds, or thousands of processors linked in parallel can act upon such data in order to present it or simulate external forces on the data or what it represents. These data sets can involve structured data, such as that organized in a database or otherwise according to a structured model, and/or unstructured data (e.g., emails, images, data blobs (binary large objects), web pages, complex event processing). By leveraging an ability of an aspect to relatively quickly focus more (or fewer) computing resources upon an objective, the cloud infrastructure system may be better available to carry out tasks on large data sets based on demand from a business, government agency, research organization, private individual, group of like-minded individuals or organizations, or other entity.

**[0538]** In various aspects, cloud infrastructure system **4502** may be adapted to automatically provision, manage and track a customer's subscription to services offered by cloud infrastructure system **4502**. Cloud infrastructure system **4502** may provide the cloud services via different deployment models. For example, services may be provided under a public cloud model in which cloud infrastructure system **4502** is owned by an organization selling cloud services (e.g., owned by Oracle) and the services are made available to the general public or different industry enterprises. As another example, services may be provided under a private cloud model in which cloud infrastructure system **4502** is operated solely for a single organization and may provide services for one or more entities within the organization. The cloud services may also be provided under a community cloud model in which cloud infrastructure system **4502** and the services provided by cloud infrastructure system **4502** are shared by several organizations in a related

community. The cloud services may also be provided under a hybrid cloud model, which is a combination of two or more different models.

**[0539]** In some aspects, the services provided by cloud infrastructure system **4502** may include one or more services provided under Software as a Service (SaaS) category, Platform as a Service (PaaS) category, Infrastructure as a Service (IaaS) category, or other categories of services including hybrid services. A customer, via a subscription order, may order one or more services provided by cloud infrastructure system **4502**. Cloud infrastructure system **4502** then performs processing to provide the services in the customer's subscription order.

**[0540]** In some aspects, the services provided by cloud infrastructure system **4502** may include, without limitation, application services, platform services and infrastructure services. In some examples, application services may be provided by the cloud infrastructure system via a SaaS platform. The SaaS platform may be configured to provide cloud services that fall under the SaaS category. For example, the SaaS platform may provide capabilities to build and deliver a suite of on-demand applications on an integrated development and deployment platform. The SaaS platform may manage and control the underlying software and infrastructure for providing the SaaS services. By utilizing the services provided by the SaaS platform, customers can utilize applications executing on the cloud infrastructure system. Customers can acquire the application services without the need for customers to purchase separate licenses and support. Various different SaaS services may be provided. Examples include, without limitation, services that provide solutions for sales performance management, enterprise integration, and business flexibility for large organizations.

**[0541]** In some aspects, platform services may be provided by the cloud infrastructure system via a PaaS platform. The PaaS platform may be configured to provide cloud services that fall under the PaaS category. Examples of platform services may include without limitation services that enable organizations (such as Oracle) to consolidate existing applications on a shared, common architecture, as well as the ability to build new applications that leverage the shared services provided by the platform. The PaaS platform may manage and control the underlying software and infrastructure for providing the PaaS services. Customers can acquire the PaaS services provided by the cloud infrastructure system without the need for customers to purchase separate licenses and support. Examples of platform services include, without limitation, Oracle Java Cloud Service (JCS), Oracle Database Cloud Service (DBCS), and others.

**[0542]** By utilizing the services provided by the PaaS platform, customers can employ programming languages and tools supported by the cloud infrastructure system and also control the deployed services. In some aspects, platform services provided by the cloud infrastructure system may include database cloud services, middleware cloud services (e.g., Oracle Fusion Middleware services), and Java cloud services. In one aspect, database cloud services may support shared service deployment models that enable organizations to pool database resources and offer customers a Database as a Service in the form of a database cloud. Middleware cloud services may provide a platform for customers to develop and deploy various business applications, and Java cloud

services may provide a platform for customers to deploy Java applications, in the cloud infrastructure system.

[0543] Various different infrastructure services may be provided by an IaaS platform in the cloud infrastructure system. The infrastructure services facilitate the management and control of the underlying computing resources, such as storage, networks, and other fundamental computing resources for customers utilizing services provided by the SaaS platform and the PaaS platform.

[0544] In certain aspects, cloud infrastructure system 4502 may also include infrastructure resources 4530 for providing the resources used to provide various services to customers of the cloud infrastructure system. In one aspect, infrastructure resources 4530 may include pre-integrated and optimized combinations of hardware, such as servers, storage, and networking resources to execute the services provided by the PaaS platform and the SaaS platform.

[0545] In some aspects, resources in cloud infrastructure system 4502 may be shared by multiple users and dynamically re-allocated per demand. Additionally, resources may be allocated to users in different time zones. For example, cloud infrastructure system 4530 may enable a first set of users in a first time zone to utilize resources of the cloud infrastructure system for a specified number of hours and then enable the re-allocation of the same resources to another set of users located in a different time zone, thereby maximizing the utilization of resources.

[0546] In certain aspects, a number of internal shared services 4532 may be provided that are shared by different components or modules of cloud infrastructure system 4502 and by the services provided by cloud infrastructure system 4502. These internal shared services may include, without limitation, a security and identity service, an integration service, an enterprise repository service, an enterprise manager service, a virus scanning and white list service, a high availability, backup and recovery service, service for enabling cloud support, an email service, a notification service, a file transfer service, and the like.

[0547] In certain aspects, cloud infrastructure system 4502 may provide comprehensive management of cloud services (e.g., SaaS, PaaS, and IaaS services) in the cloud infrastructure system. In one aspect, cloud management functionality may include capabilities for provisioning, managing and tracking a customer's subscription received by cloud infrastructure system 4502, and the like.

[0548] In one aspect, as depicted in the figure, cloud management functionality may be provided by one or more modules, such as an order management module 4520, an order orchestration module 4522, an order provisioning module 4524, an order management and monitoring module 4526, and an identity management module 4528. These modules may include or be provided using one or more computers and/or servers, which may be general purpose computers, specialized server computers, server farms, server clusters, or any other appropriate arrangement and/or combination.

[0549] In exemplary operation 4534, a customer using a client device, such as client device 4504, 4506 or 4508, may interact with cloud infrastructure system 4502 by requesting one or more services provided by cloud infrastructure system 4502 and placing an order for a subscription for one or more services offered by cloud infrastructure system 4502. In certain aspects, the customer may access a cloud User Interface (UI), cloud UI 4512, cloud UI 4514 and/or cloud

UI 4516 and place a subscription order via these UIs. The order information received by cloud infrastructure system 4502 in response to the customer placing an order may include information identifying the customer and one or more services offered by the cloud infrastructure system 4502 that the customer intends to subscribe to.

[0550] After an order has been placed by the customer, the order information is received via the cloud UIs, 4545, 4514 and/or 4516.

[0551] At operation 4536, the order is stored in order database 4518. Order database 4518 can be one of several databases operated by cloud infrastructure system 4518 and operated in conjunction with other system elements.

[0552] At operation 4538, the order information is forwarded to an order management module 4520. In some instances, order management module 4520 may be configured to perform billing and accounting functions related to the order, such as verifying the order, and upon verification, booking the order.

[0553] At operation 4540, information regarding the order is communicated to an order orchestration module 4522. Order orchestration module 4522 may utilize the order information to orchestrate the provisioning of services and resources for the order placed by the customer. In some instances, order orchestration module 4522 may orchestrate the provisioning of resources to support the subscribed services using the services of order provisioning module 4524.

[0554] In certain aspects, order orchestration module 4522 enables the management of business processes associated with each order and applies business logic to determine whether an order should proceed to provisioning. At operation 4542, upon receiving an order for a new subscription, order orchestration module 4522 sends a request to order provisioning module 4524 to allocate resources and configure those resources needed to fulfill the subscription order. Order provisioning module 4524 enables the allocation of resources for the services ordered by the customer. Order provisioning module 4524 provides a level of abstraction between the cloud services provided by cloud infrastructure system 4500 and the physical implementation layer that is used to provision the resources for providing the requested services. Order orchestration module 4522 may thus be isolated from implementation details, such as whether or not services and resources are actually provisioned on the fly or pre-provisioned and only allocated/assigned upon request.

[0555] At operation 4544, once the services and resources are provisioned, a notification of the provided service may be sent to customers on client devices 4504, 4506 and/or 4508 by order provisioning module 4524 of cloud infrastructure system 4502.

[0556] At operation 4546, the customer's subscription order may be managed and tracked by an order management and monitoring module 4526. In some instances, order management and monitoring module 4526 may be configured to collect usage statistics for the services in the subscription order, such as the amount of storage used, the amount data transferred, the number of users, and the amount of system up time and system down time.

[0557] In certain aspects, cloud infrastructure system 4500 may include an identity management module 4528. Identity management module 4528 may be configured to provide identity services, such as access management and authorization services in cloud infrastructure system 4500. In some

aspects, identity management module **4528** may control information about customers who wish to utilize the services provided by cloud infrastructure system **4502**. Such information can include information that authenticates the identities of such customers and information that describes which actions those customers are authorized to perform relative to various system resources (e.g., files, directories, applications, communication ports, memory segments, etc.) Identity management module **4528** may also include the management of descriptive information about each customer and about how and by whom that descriptive information can be accessed and modified.

[0558] FIG. 46 illustrates an exemplary computer system **4600**, in which various aspects of the present invention may be implemented. The system **4600** may be used to implement any of the computer systems described above. As shown in the figure, computer system **4600** includes a processing unit **4604** that communicates with a number of peripheral subsystems via a bus subsystem **4602**. These peripheral subsystems may include a processing acceleration unit **4606**, an I/O subsystem **4608**, a storage subsystem **4618** and a communications subsystem **4624**. Storage subsystem **4618** includes tangible computer-readable storage media **4622** and a system memory **4610**.

[0559] Bus subsystem **4602** provides a mechanism for letting the various components and subsystems of computer system **4600** communicate with each other as intended. Although bus subsystem **4602** is shown schematically as a single bus, alternative aspects of the bus subsystem may utilize multiple buses. Bus subsystem **4602** may be any of several types of bus structures including a memory bus or memory controller, a peripheral bus, and a local bus using any of a variety of bus architectures. For example, such architectures may include an Industry Standard Architecture (ISA) bus, Micro Channel Architecture (MCA) bus, Enhanced ISA (EISA) bus, Video Electronics Standards Association (VESA) local bus, and Peripheral Component Interconnect (PCI) bus, which can be implemented as a Mezzanine bus manufactured to the IEEE P4686.1 standard.

[0560] Processing unit **4604**, which can be implemented as one or more integrated circuits (e.g., a conventional microprocessor or microcontroller), controls the operation of computer system **4600**. One or more processors may be included in processing unit **4604**. These processors may include single core or multicore processors. In certain aspects, processing unit **4604** may be implemented as one or more independent processing units **4632** and/or **4634** with single or multicore processors included in each processing unit. In other aspects, processing unit **4604** may also be implemented as a quad-core processing unit formed by integrating two dual-core processors into a single chip.

[0561] In various aspects, processing unit **4604** can execute a variety of programs in response to program code and can maintain multiple concurrently executing programs or processes. At any given time, some or all of the program code to be executed can be resident in processing unit(s) **4604** and/or in storage subsystem **4618**. Through suitable programming, processing unit(s) **4604** can provide various functionalities described above. Computer system **4600** may additionally include a processing acceleration unit **4606**, which can include a digital signal processor (DSP), a special-purpose processor, and/or the like.

[0562] I/O subsystem **4608** may include user interface input devices and user interface output devices. User inter-

face input devices may include a keyboard, pointing devices such as a mouse or trackball, a touchpad or touch screen incorporated into a display, a scroll wheel, a click wheel, a dial, a button, a switch, a keypad, audio input devices with voice command recognition systems, microphones, and other types of input devices. User interface input devices may include, for example, motion sensing and/or gesture recognition devices such as the Microsoft Kinect® motion sensor that enables users to control and interact with an input device, such as the Microsoft Xbox® 360 game controller, through a natural user interface using gestures and spoken commands. User interface input devices may also include eye gesture recognition devices such as the Google Glass® blink detector that detects eye activity (e.g., ‘blinking’ while taking pictures and/or making a menu selection) from users and transforms the eye gestures as input into an input device (e.g., Google Glass®). Additionally, user interface input devices may include voice recognition sensing devices that enable users to interact with voice recognition systems (e.g., Siri® navigator), through voice commands.

[0563] User interface input devices may also include, without limitation, three dimensional (3D) mice, joysticks or pointing sticks, gamepads and graphic tablets, and audio/visual devices such as speakers, digital cameras, digital camcorders, portable media players, webcams, image scanners, fingerprint scanners, barcode reader 3D scanners, 3D printers, laser rangefinders, and eye gaze tracking devices. Additionally, user interface input devices may include, for example, medical imaging input devices such as computed tomography, magnetic resonance imaging, position emission tomography, medical ultrasonography devices. User interface input devices may also include, for example, audio input devices such as MIDI keyboards, digital musical instruments and the like.

[0564] User interface output devices may include a display subsystem, indicator lights, or non-visual displays such as audio output devices, etc. The display subsystem may be a cathode ray tube (CRT), a flat-panel device, such as that using a liquid crystal display (LCD) or plasma display, a projection device, a touch screen, and the like. In general, use of the term “output device” is intended to include all possible types of devices and mechanisms for outputting information from computer system **4600** to a user or other computer. For example, user interface output devices may include, without limitation, a variety of display devices that visually convey text, graphics and audio/video information such as monitors, printers, speakers, headphones, automotive navigation systems, plotters, voice output devices, and modems.

[0565] Computer system **4600** may comprise a storage subsystem **4618** that comprises software elements, shown as being currently located within a system memory **4610**. System memory **4610** may store program instructions that are loadable and executable on processing unit **4604**, as well as data generated during the execution of these programs.

[0566] Depending on the configuration and type of computer system **4600**, system memory **4610** may be volatile (such as random access memory (RAM)) and/or non-volatile (such as read-only memory (ROM), flash memory, etc.) The RAM typically contains data and/or program modules that are immediately accessible to and/or presently being operated and executed by processing unit **4604**. In some implementations, system memory **4610** may include multiple different types of memory, such as static random access



memory (SRAM) or dynamic random access memory (DRAM). In some implementations, a basic input/output system (BIOS), containing the basic routines that help to transfer information between elements within computer system 4600, such as during start-up, may typically be stored in the ROM. By way of example, and not limitation, system memory 4610 also illustrates application programs 4612, which may include client applications, Web browsers, mid-tier applications, relational database management systems (RDBMS), etc., program data 4614, and an operating system 4616. By way of example, operating system 4616 may include various versions of Microsoft Windows®, Apple Macintosh®, and/or Linux operating systems, a variety of commercially-available UNIX® or UNIX-like operating systems (including without limitation the variety of GNU/Linux operating systems, the Google Chrome® OS, and the like) and/or mobile operating systems such as iOS, Windows® Phone, Android® OS, BlackBerry® 10 OS, and Palm® OS operating systems.

[0567] Storage subsystem 4618 may also provide a tangible computer-readable storage medium for storing the basic programming and data constructs that provide the functionality of some aspects. Software (programs, code modules, instructions) that when executed by a processor provide the functionality described above may be stored in storage subsystem 4618. These software modules or instructions may be executed by processing unit 4604. Storage subsystem 4618 may also provide a repository for storing data used in accordance with the present invention.

[0568] Storage subsystem 4600 may also include a computer-readable storage media reader 4620 that can further be connected to computer-readable storage media 4622. Together and, optionally, in combination with system memory 4610, computer-readable storage media 4622 may comprehensively represent remote, local, fixed, and/or removable storage devices plus storage media for temporarily and/or more permanently containing, storing, transmitting, and retrieving computer-readable information.

[0569] Computer-readable storage media 4622 containing code, or portions of code, can also include any appropriate media known or used in the art, including storage media and communication media, such as but not limited to, volatile and non-volatile, removable and non-removable media implemented in any method or technology for storage and/or transmission of information. This can include tangible, non-transitory computer-readable storage media such as RAM, ROM, electronically erasable programmable ROM (EEPROM), flash memory or other memory technology, CD-ROM, digital versatile disk (DVD), or other optical storage, magnetic cassettes, magnetic tape, magnetic disk storage or other magnetic storage devices, or other tangible computer readable media. When specified, this can also include nontangible, transitory computer-readable media, such as data signals, data transmissions, or any other medium which can be used to transmit the desired information and which can be accessed by computing system 4600.

[0570] By way of example, computer-readable storage media 4622 may include a hard disk drive that reads from or writes to non-removable, nonvolatile magnetic media, a magnetic disk drive that reads from or writes to a removable, nonvolatile magnetic disk, and an optical disk drive that reads from or writes to a removable, nonvolatile optical disk such as a CD ROM, DVD, and Blu-Ray® disk, or other optical media. Computer-readable storage media 4622 may

include, but is not limited to, Zip® drives, flash memory cards, universal serial bus (USB) flash drives, secure digital (SD) cards, DVD disks, digital video tape, and the like. Computer-readable storage media 4622 may also include, solid-state drives (SSD) based on non-volatile memory such as flash-memory based SSDs, enterprise flash drives, solid state ROM, and the like, SSDs based on volatile memory such as solid state RAM, dynamic RAM, static RAM, DRAM-based SSDs, magnetoresistive RAM (MRAM) SSDs, and hybrid SSDs that use a combination of DRAM and flash memory based SSDs. The disk drives and their associated computer-readable media may provide non-volatile storage of computer-readable instructions, data structures, program modules, and other data for computer system 4600.

[0571] Communications subsystem 4624 provides an interface to other computer systems and networks. Communications subsystem 4624 serves as an interface for receiving data from and transmitting data to other systems from computer system 4600. For example, communications subsystem 4624 may enable computer system 4600 to connect to one or more devices via the Internet. In some aspects, communications subsystem 4624 can include radio frequency (RF) transceiver components for accessing wireless voice and/or data networks (e.g., using cellular telephone technology, advanced data network technology, such as 3G, 4G or EDGE (enhanced data rates for global evolution), WiFi (IEEE 802.11 family standards, or other mobile communication technologies, or any combination thereof), global positioning system (GPS) receiver components, and/or other components. In some aspects, communications subsystem 4624 can provide wired network connectivity (e.g., Ethernet) in addition to or instead of a wireless interface.

[0572] In some aspects, communications subsystem 4624 may also receive input communication in the form of structured and/or unstructured data feeds 4626, event streams 4628, event updates 4646, and the like on behalf of one or more users who may use computer system 4600.

[0573] By way of example, communications subsystem 4624 may be configured to receive unstructured data feeds 4626 in real-time from users of social media networks and/or other communication services such as Twitter® feeds, Facebook® updates, web feeds such as Rich Site Summary (RSS) feeds, and/or real-time updates from one or more third party information sources.

[0574] Additionally, communications subsystem 4624 may also be configured to receive data in the form of continuous data streams, which may include event streams 4628 of real-time events and/or event updates 4646, that may be continuous or unbounded in nature with no explicit end. Examples of applications that generate continuous data may include, for example, sensor data applications, financial tickers, network performance measuring tools (e.g. network monitoring and traffic management applications), click-stream analysis tools, automobile traffic monitoring, and the like.

[0575] Communications subsystem 4624 may also be configured to output the structured and/or unstructured data feeds 4626, event streams 4628, event updates 4646, and the like to one or more databases that may be in communication with one or more streaming data source computers coupled to computer system 4600.

[0576] Computer system 4600 can be one of various types, including a handheld portable device (e.g., an iPhone® cellular phone, an iPad® computing tablet, a PDA), a wearable device (e.g., a Google Glass® head mounted display), a PC, a workstation, a mainframe, a kiosk, a server rack, or any other data processing system.

[0577] Due to the ever-changing nature of computers and networks, the description of computer system 4600 depicted in the figure is intended only as a specific example. Many other configurations having more or fewer components than the system depicted in the figure are possible. For example, customized hardware might also be used and/or particular elements might be implemented in hardware, firmware, software (including applets), or a combination. Further, connection to other computing devices, such as network input/output devices, may be employed. Based on the disclosure and teachings provided herein, a person of ordinary skill in the art will appreciate other ways and/or methods to implement the various aspects.

[0578] In the foregoing specification, aspects of the invention are described with reference to specific aspects thereof, but those skilled in the art will recognize that the invention is not limited thereto. Various features and aspects of the above-described invention may be used individually or jointly. Further, aspects can be utilized in any number of environments and applications beyond those described herein without departing from the broader spirit and scope of the specification. The specification and drawings are, accordingly, to be regarded as illustrative rather than restrictive.

What is claimed is:

1. A method for validating argumentation in text, the method comprising:

creating a discourse tree from text comprising fragments, wherein the discourse tree comprises a plurality of nodes, each nonterminal node representing a rhetorical relationship between two of the fragments and each terminal node of the nodes of the discourse tree is associated with one of the fragments;

forming a communicative discourse tree from the discourse tree by matching each fragment that has a verb to a verb signature; and

identifying that the text comprises an argument corresponding to a claim by applying a classification model trained to detect argumentation to the communicative discourse tree;

evaluating a consistency of the argument with respect to itself and with respect to a domain definition clause that is associated with a domain of the text by solving a logic system that comprises:

(a) a fixed part comprising a term of the claim and the domain definition clause, and

(b) a variable part comprising a set of defeasible rules from the communicative discourse tree and a fact from a communicative action of the communicative discourse tree; and

responsive to determining that the evaluated consistency is greater than a threshold, forming a textual response from the text and outputting the textual response to an external device.

2. The method of claim 1, wherein solving the logic system further comprises:

determining a defeasible derivation comprising a set of non-contradictory defeasible rules of the defeasible set of rules;

creating one or more defeater arguments from the fact; constructing, from the defeasible derivation, a dialectic tree comprising a root node that represents the argument and leaf nodes that each represent a defeater argument of the defeater arguments;

evaluating the dialectic tree by recursively evaluating the defeater arguments; and

responsive to determining that none of the defeater arguments are contradictory with the defeasible derivation, identifying the argument as consistent.

3. The method of claim 1, wherein the matching comprises:

determining, for each word in an fragment, a role of the word within the fragment;

matching a thematic role of a particular verb signature of a set of verb signatures with a determined role in fragment, wherein each verb signature comprises the verb and a respective thematic role that describes a relationship between the verb and other words; and associating the particular verb signature with the fragment.

4. The method of claim 3, wherein a verb signature includes an ordered list of thematic roles.

5. The method of claim 3, wherein the classification model (i) is a support vector machine with tree kernel learning or (ii) uses nearest neighbor learning of maximal common sub-trees.

6. The method of claim 1, wherein applying the classification model to the text comprises computing a level of similarity between the communicative discourse tree and one or more communicative discourse trees from a training set of communicative discourse trees, wherein the classification model is trained using the training set of communicative discourse trees, the method further comprising determining, based on the level of similarity, whether the text contains an argumentation or no argumentation.

7. The method of claim 1, further comprising providing the evaluated consistency to the external device.

8. A system comprising:

a non-transitory computer-readable medium storing computer-executable program instructions; and

a processing device communicatively coupled to the non-transitory computer-readable medium for executing the computer-executable program instructions, wherein executing the computer-executable program instructions configures the processing device to perform operations comprising:

creating a discourse tree from text comprising fragments, wherein the discourse tree comprises a plurality of nodes, each nonterminal node representing a rhetorical relationship between two of the fragments and each terminal node of the nodes of the discourse tree is associated with one of the fragments;

forming a communicative discourse tree from the discourse tree by matching each fragment that has a verb to a verb signature; and

identifying that the text comprises an argument corresponding to a claim by applying a classification model trained to detect argumentation to the communicative discourse tree;

- evaluating a consistency of the argument with respect to itself and with respect to a domain definition clause that is associated with a domain of the text by solving the a logic system that comprises:
- (a) a fixed part comprising a term of the claim and the domain definition clause, and
  - (b) a variable part comprising a set of defeasible rules from the communicative discourse tree and a fact from a communicative actin of the communicative discourse tree; and
- responsive to determining that the evaluated consistency is lower than a threshold, forming a textual response from the text and outputting the textual response to an external device.
- 9.** The system of claim **8**, wherein solving the logic system further comprises:
- determining a defeasible derivation comprising a set of non-contradictory defeasible rules of the defeasible set of rules;
  - creating one or more defeater arguments from the fact;
  - constructing, from the defeasible derivation, a dialectic tree comprising a root node that represents the argument and leaf nodes that each represent a defeater argument of the defeater arguments;
  - evaluating the dialectic tree by recursively evaluating the defeater arguments; and
  - responsive to determining that one or more of the defeater arguments are contradictory with the defeasible derivation, identifying the argument as inconsistent.
- 10.** The system of claim **8**, wherein the matching comprises:
- determining, for each word in a fragment, a role of the word within the fragment;
  - matching a thematic role of a particular verb signature of a set of verb signatures with a determined role in fragment, wherein each verb signature comprises the verb and a respective thematic role that describes a relationship between the verb and other words; and
  - associating the particular verb signature with the fragment.
- 11.** The system of claim **10**, wherein a verb signature includes an ordered list of thematic roles.
- 12.** The system of claim **10**, wherein the classification model is (i) a support vector machine with tree kernel learning or (ii) uses nearest neighbor learning of maximal common sub-trees.
- 13.** The system of claim **8**, wherein applying the classification model to the text comprises computing a level of similarity between the communicative discourse tree and one or more communicative discourse trees from a training set of communicative discourse trees, wherein the classification model is trained using the training set of communicative discourse trees, and wherein the operations further comprise determining, based on the level of similarity, whether the text contains an argumentation or no argumentation.
- 14.** The system of claim **8**, the operations further comprising adjusting the text on the evaluated consistency and providing the adjusted text to the external device.
- 15.** A non-transitory computer-readable storage medium storing computer-executable program instructions, wherein when executed by a processing device, the computer-executable program instructions cause the processing device to perform operations comprising:
- creating a discourse tree from text comprising fragments, wherein the discourse tree comprises a plurality of nodes, each nonterminal node representing a rhetorical relationship between two of the fragments and each terminal node of the nodes of the discourse tree is associated with one of the fragments;
  - forming a communicative discourse tree from the discourse tree by matching each fragment that has a verb to a verb signature; and
  - identifying that the text comprises an argument corresponding to a claim by applying a classification model trained to detect argumentation to the communicative discourse tree;
  - evaluating a consistency of the argument with respect to itself and with respect to a domain definition clause that is associated with a domain of the text by solving the a logic system that comprises:
    - (a) a fixed part comprising a term of the claim and the domain definition clause, and
    - (b) a variable part comprising a set of defeasible rules from the communicative discourse tree and a fact from a communicative actin of the communicative discourse tree; and
  - responsive to determining that the evaluated consistency is greater than a threshold, forming a textual response from the text and outputting the textual response to an external device.
- 16.** The non-transitory computer-readable storage medium of claim **15**, wherein solving the logic system further comprises:
- determining a defeasible derivation, the defeasible derivation comprising a set of non-contradictory defeasible rules from the defeasible set of rules;
  - creating one or more defeater arguments from the fact;
  - constructing, from the defeasible derivation, a dialectic tree comprising a root node that represents the argument and leaf nodes that represent the defeater arguments;
  - evaluating the dialectic tree by recursively evaluating the defeater arguments; and
  - responsive to determining that none of the defeater arguments are contradictory with the defeasible derivation, identifying the argument as consistent.
- 17.** The non-transitory computer-readable storage medium of claim **15**, wherein the matching comprises:
- accessing a plurality of verb signatures, wherein each verb signature comprises the verb of the respective fragment and a sequence of thematic roles, wherein thematic roles describe a relationship between the verb and related words;
  - determining, for each verb signature of the plurality of verb signatures, a plurality of thematic roles of the verb signature that matches a role of a word in a respective fragment;
  - selecting a particular verb signature from the plurality of verb signatures based on the particular verb signature comprising a highest number of matches; and
  - associating the particular verb signature with the fragment.
- 18.** The non-transitory computer-readable storage medium of claim **17**, wherein a verb signature includes an ordered list of thematic roles.
- 19.** The non-transitory computer-readable storage medium of claim **17**, wherein the classification model (i) is

a support vector machine with tree kernel learning or (ii) uses nearest neighbor learning of maximal common subtrees.

**20.** The non-transitory computer-readable storage medium of claim **15**, wherein applying the classification model to the text comprises computing a level of similarity between the communicative discourse tree and one or more communicative discourse trees from a training set of communicative discourse trees, wherein the classification model is trained using the training set of communicative discourse trees, the operations further comprising determining, based on the level of similarity, whether the text contains an argumentation or no argumentation.

\* \* \* \* \*